

# TOOLS & EQUIPMENT.

**AUTEL**<sup>®</sup>

**MAXICHARGER ELECTRIC VEHICLE CHARGING SOLUTIONS**



**ENQUIRE TODAY ABOUT THE FULL RANGE OF AUTEL MAXICHARGER ELECTRIC VEHICLE CHARGING SOLUTIONS  
CONTACT NAPA AUTO PARTS EQUIPMENT ON 0800 800 073**

**Handijack**<sup>®</sup>  
MACHINERY

**NEW RANGE OF GARAGE EQUIPMENT  
AVAILABLE NOW**



**JANUARY/MARCH 2024**

ALL PRICES EXCLUDE GST. PRICES VALID 01/01/24 UNTIL 31/03/24.  
Copyright © 2024 GPC Asia Pacific

**NAPA**  
**AUTO PARTS**

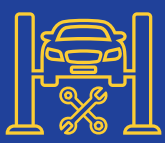

# AIR CONDITIONING SERVICE

## Fully Automatic A/C Service Station with Printer (Entry Level)

- Fully automatic and individual service functions selectable
- Spark proofed electrical system (AC1234-3IP Only)
- Recovery Performance - up to 95%
- Vacuum Performance measured on A/C system < 500 micron
- Automatic Oil Injection (PAG or POE)
- Environmentally friendly
- Refrigerant Charge: ± 15 gram accuracy
- Wi-Fi connectivity / mobile app available in android and iOS
- System flushing (optional kit)
- Integrated printer
- AU database
- 2 Year Warranty
- Made in Europe

AC1X34-3IP - R134a

# \$6,450

OR \$36 PW\* SEE PAGE 30 FOR FINANCE DETAILS.

**ROBINAIR.**

Includes Wi-Fi dongle, cover and calibration check weight

## 95% RECOVERY RATE



Also Available

AC1234-3IP R1234YF \$6,450 OR \$36 PW\* SEE PAGE 30

## Fully Automatic A/C Service Station with Printer (Mid-Tier)

- Fully automatic and individual service functions selectable
- Spark proofed electrical system (AC1234-5IP Only)
- 99% recovery rate - Deep Recovery function ensures fast and complete evacuation of the AC system
- Dual-stage 170L/min vacuum pump, Fast and complete evacuation of the largest automotive AC system
- PAG/POE oil injection - Innovative oil bottle system suitable for vehicles with conventional engines and hybrid/electric vehicles
- Calculated electronic air purge prevents accidental refrigerant emission
- Refrigerant Charge: ± 15 gram accuracy
- Wi-Fi connectivity/mobile app available in android and iOS
- System flushing (optional kit)
- Integrated printer
- AU database
- 2 Year Warranty
- Made in Europe

AC1X34-5IP - R134a

# \$9,800

OR \$54 PW\* SEE PAGE 30 FOR FINANCE DETAILS.

**ROBINAIR.**

Includes Wi-Fi dongle, cover and calibration check weight

## 99% RECOVERY RATE



**SPECIAL ORDER AVAILABLE ON REQUEST**

Also Available

AC1234-5IP R1234YF \$9,800 OR \$54 PW\* SEE PAGE 30

## Fully Automatic A/C Service Station with Printer (Premium)

- Fully automatic and individual service functions selectable
- Spark proofed electrical system (AC1234-7IP Only)
- 99% recovery rate - Deep Recovery function ensures fast and complete evacuation of the AC system
- Swivelling control console and 7" colour display ensures optimal human interface experience
- Smartphone app enables remote communication of ACS unit at your fingertips - Android and iOS
- Integrated pressure leak detection system for inert gas (NOx, nitrogen, formiergas)
- Innovative oil bottle system and internal flushing of the unit make it suitable for vehicles with conventional engines and hybrid vehicles (PAG/POE) and avoids the danger of cross contamination of lubricants
- Vehicle flushing function (optional adaptor kit required)
- Integrated printer
- AU database
- 2 Year Warranty
- Made in Europe

AC1X34-7IP - R134a

# \$10,999

OR \$61 PW\* SEE PAGE 30 FOR FINANCE DETAILS.

**ROBINAIR.**

Includes Wi-Fi dongle, cover and calibration check weight

## 99% RECOVERY RATE



Also Available

AC1234-7IP R1234YF \$10,999 OR \$61 PW\* SEE PAGE 30

## Full Automatic A/C Service Station for R134a

- R134a (passenger & light commercial vehicles)
- Suitable for low to medium volume applications
- Fully automatic operation
- Oil injection (weight)
- 100L/min vacuum pump
- 12kg tank capacity
- 2m hose length
- Automatic and manual air purge
- Low/high pressure gauges
- Vehicle specifications database
- LCD display and button controls
- Hybrid compatible
- Compact size with hose storage
- New/old oil bottles
- Adjustable vacuum settings
- Easy to read gauges
- Multiple languages
- Single phase 240V
- 1 Year Warranty
- Made in Europe

PROSET134

# \$6,950

OR \$40 PW\* SEE PAGE 30 FOR FINANCE DETAILS.

**cps**



**EXCLUSIVE!**

# AIR CONDITIONING SERVICE

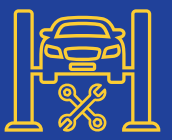

## Full Automatic A/C Service Station for R134A and Hybrid with Hose Flushing

Mastercool USA introduces its new ARCTIC COMMANDER line of RRR machines. Equipped with the latest technology, all models come standard with an 8" color touch screen command center. The graphic interface will enable navigation through all of the functions and features with the greatest of ease. There is no longer a need to read any external instructions or paper manuals, simply sit back and watch as the information is played on the color command center. The Arctic Commander series of machines incorporate a powerful windows based tablet, making database and software upgrades a breeze. Wi-Fi capability allows for real time, interactive communication. The pre-installed team viewer program lets our technicians access any machine throughout the world to aid with any troubleshooting issues.

### Features:

- Remote updates will keep the machine up to date with the latest software
- Automatic and manual procedures
- Refrigerant database
- Automatic vacuum leak test: programmable
- Automatic oil discharge
- Automatic and manual air purge
- e-Printing function via Wi-Fi for easy cataloging of jobs
- Made in the USA

EQX3000

**\$9,650**

OR \$55 PW\* SEE PAGE 30 FOR FINANCE DETAILS.

**BONUS\***  
Thermometer/Hydrometer  
TOX52234-BT  
\*While Stocks Last



**EXCLUSIVE!**

## Full Automatic A/C Service Station for R1234yf

Mastercool USA introduces its new ARCTIC COMMANDER line of RRR machines. Equipped with the latest technology, all models come standard with an 8" colour touchscreen command centre. The graphic interface will enable navigation through all of the functions and features with the greatest of ease. Incorporating a powerful windows based tablet, making database and software upgrades a breeze. Wi-Fi capability allows for real time, interactive communication. The pre-installed team viewer program lets our technicians access any machine throughout the world to aid with any troubleshooting issues.

### Features:

- Remote updates will keep the machine up to date with the latest software
- Automatic and manual procedures
- Refrigerant database
- Automatic vacuum leak test: programmable
- Multiple languages
- Automatic oil discharge
- Automatic and manual air purge
- e-Printing function via Wi-Fi for easy cataloging of jobs
- Made in the USA

EQX4000EX

**\$10,500**

OR \$61 PW\* SEE PAGE 30 FOR FINANCE DETAILS.

**BONUS\***  
Thermometer/Hydrometer  
TOX52234-BT  
\*While Stocks Last



### Also Available

EQX4000	Fully Automatic A/C Service Station for 1234YF with Refrigerant Identifier	<b>\$14,250</b> OR \$80 PW* SEE PAGE 30
---------	--	---



**EXCLUSIVE!**



## Compact Digital Manifold Set

### Features:

- R134a, can be converted to R1234yf with optional accessory
- Compact 2-way aluminum manifold
- Large blue back-lit LCD gauges with rubber protection
- Large sight glass
- Easy grip knobs
- Front mounted chrome fittings

### Specifications:

Low Pressure Range	-14.5-500psi (-0.1-3.4MPa)
High Pressure Range	-14.5-800psi (-0.1-5.5MPa)
Resolution	0.5psi
Accuracy	+/-0.5 FS
Over Range Alarm	Display -OL-
Battery Life	6 Months (Approx.)
Sampling Rate	1 Second

TOX84472

**\$750**

### Optional Accessories

TOX63736-K	R134A to R1234YF Conversion Kit	<b>\$145</b>
TOX83736-K	R134A to R1234YF Conversion Kit	<b>\$205</b>



**EXCLUSIVE!**

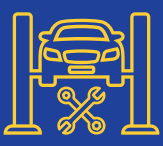

# AIR CONDITIONING SERVICE

## 2 Way Manifold Set for R134a & R1234yf with Hoses and Couplers for R134a

- Features:**
- R134a as standard
  - Convertible to R1234yf with optional accessory
  - 2 ports
  - 80mm updated gauges
  - Deluxe fittings
- TOX143M**

**\$425**



**EXCLUSIVE!**

**Optional Accessories**

TOX63736-K	R134A to R1234YF Conversion Kit	<b>\$145</b>
TOX83736-K	R134A to R1234YF Conversion Kit	<b>\$205</b>



## Recovery Machine Twin Piston

- Features:**
- Revolutionary double piston oil-less compressor
  - Safety high pressure switch
  - Largest volume recovery rate in market
  - For use with all refrigerants including R410A
  - Injection molded high density polyethylene case for maximum durability
  - Front cover has bumper guards built in to reduce damage to the control knobs
  - Spark free
- EQX69361**

**\$2,500**



**EXCLUSIVE!**

**COMPATIBLE WITH R1234YF**

**Also Available**  
EQX69362 Filter & Sight Glass **\$160**



## 4 Way Manifold Set for R134a & R1234yf with Hoses and Couplers for R134a

- Features:**
- R134a as standard
  - Convertible to R1234yf with optional accessory
  - 4 ports
  - 80mm updated gauges
  - Deluxe fittings
- TOX144M**

**\$495**

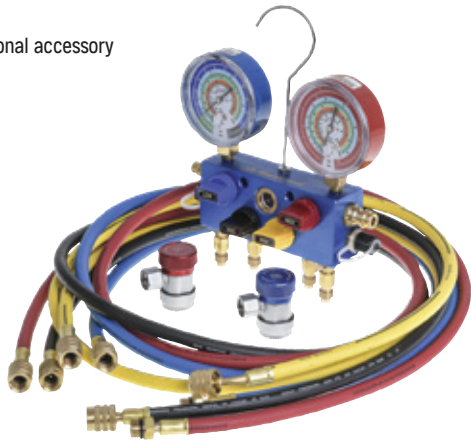

**EXCLUSIVE!**

**Optional Accessories**

TOX63736-K	R134A to R1234YF Conversion Kit	<b>\$145</b>
TOX83736-K	R134A to R1234YF Conversion Kit	<b>\$205</b>



## Mini Recovery Machine Twin Piston

- Features:**
- \*1/2 HP motor
  - Operating Temperature: 0 to 50°C
  - Compatible with all CFC, HCFC, HFC's, and Combustible gases
  - Spark free
  - Compact Design
- EQX69400**

**\$1,900**



**EXCLUSIVE!**

**COMPATIBLE WITH R1234YF**



## Refrigerant Leak Detector

- Features:**
- Super sensitive function for locating small leaks
  - Flexible probe
  - LED display
  - Powerful microprocessor
  - 2,000 Hours sensor life
  - Less than 1 second response time
  - 30 Hours battery life (2x C Batteries)
  - Heated tin oxide sensing element
- TOX55900**

**\$599**



**EXCLUSIVE!**

**COMPATIBLE WITH ALL REFRIGERANTS**



## Premium Infrared Refrigerant Leak Detector

- Features:**
- Innovative infrared sensor offers an extended sensor life of 10 years
  - Easily select high, medium and low sensitivity levels with a maximum sensitivity up to 0.14 oz/yr
  - Advanced high resolution TFT screen provides clear and easy readings using color graphics that show leakage, sensitivity, battery level and sensor fault indicators
  - Peak button indicates the maximum leak detected during measurements
  - Designed to meet EN14624, SAE1627, SAE2791 and SAE2913 standards
- TOX55600**

**\$950**



**EXCLUSIVE!**

**COMPATIBLE WITH ALL REFRIGERANTS**



## High Performance Vacuum Pump 170 L/Min

- Features:**
- Easy grip handle
  - Spark free
  - Cooling fins keep temperature cooler during extended operation
  - Large oil level sight glass with max/min level indicator
  - Gas ballast valve helps prevent oil contamination caused by high moisture
  - Refined cartridge machining process creates an improved surface finish extending the longevity of the pump
  - Stages: 2
  - Free air displacement: 170L/min
  - Ultimate vacuum: 15 microns
  - Motor: 1/2 HP
  - Pump speed: 1,440rpm
  - Power: 240 Volt
- TOX1350**

**\$875**



**EXCLUSIVE!**

**COMPATIBLE WITH ALL REFRIGERANTS**



## Electronic Charging Scale with Bluetooth

- Features:**
- Extra-large LCD screen
  - Bluetooth® (works with Mastercool® connect app)
  - 110kg Capacity
  - Strong aluminum base
  - Non-slip platform
  - Custom charge programming
  - Pause/charge function
  - Tank capacity programming
  - Repeat function
  - 38 Hour battery life
  - Accuracy: +/- 0.05% of reading
  - Heavy duty carrying case
- TOX8210**

**\$495**



**EXCLUSIVE!**





## 2 Ton Hydraulic Garage Jack

High lifter with long reach, ideal for cars with low clearance.

### Features:

- Very low minimum height of only 80mm
- Manual dead man's release for optimum safety when lowering

### Specifications:

Lifting Range 80-495mm

DK20



**\$619**



## 2 Ton Hydraulic Quick Jack

Designed for passenger cars and vans.

### Features:

- Very low minimum height of only 80mm
- Manual dead man's release for optimum safety when lowering

### Specifications:

Lifting Range 80-495mm

DK20Q



**\$751**



## 4 Ton Hydraulic Quick Jack

### Features:

- Jack for trucks, agricultural machinery, and contractors' machines
- Low minimum height of only 140mm
- Can be fitted with pneumatic tyres (optional)
- Fitted with quick-lift pedal for easy reach of lifting point

### Specifications:

Lifting Range 140-600mm

DK40Q



**\$1,670**



## 6 Ton Hydraulic Garage Jack

### Features:

- Jack for trucks, agricultural machinery, and contractors' machines
- Low minimum height of only 140mm
- Wide and robust frame made of high-strength steel
- Fitted with quick-lift pedal for easy reach of lifting point

### Specifications:

Lifting Range 140-600mm

DK60Q



**\$2,244**



## Portable Air Hydraulic Jack 2 Stage 25/10 Ton

### Features:

- Low weight of only 28kg
- Handle can be used for carrying, lifting, lowering, and manoeuvring
- Built-in safety overload valve
- Hand-operated dead-man's control for safety whilst lifting and lowering

### Specifications:

Lifting Range 160-320mm

B252



**\$3,650**

OR \$20 PW\* SEE PAGE 30 FOR FINANCE DETAILS.



## Air Hydraulic Jack 2 Stage 25/10 Ton

### Features:

- For heavy-duty, intensive commercial use
- Hard chromium plated rams for long life
- Hand-operated dead-man's control
- With 2 extensions (50/100mm)

### Specifications:

Lifting Range 180-380mm

252



**\$3,123**

OR \$15 PW\* SEE PAGE 30 FOR FINANCE DETAILS.



## Air Hydraulic Jack 3 Stage 50/25/10 Ton

### Features:

- Designed for heavy-duty, intensive commercial use
- Minimum height of only 150mm combined with a high lifting capacity
- Telescopic cylinders ensure a high capacity combined with a low minimum height

### Specifications:

Lifting Range 150-335mm

503



**\$5,440**

OR \$27 PW\* SEE PAGE 30 FOR FINANCE DETAILS.



## Air Hydraulic Jack 3 Stage 50/25/10 Ton

### Features:

- Designed for heavy-duty, intensive commercial use
- Minimum height of only 220mm combined with a high lifting capacity
- Telescopic cylinders ensure a high capacity combined with a low minimum height

### Specifications:

Lifting Range 220-560mm

503H



**\$5,100**

OR \$25 PW\* SEE PAGE 30 FOR FINANCE DETAILS.



## 1.2 Ton Hydraulic Transmission Jack with 2-Stage Telescopic Cylinder

### Features:

- Made especially for lifting heavy duty truck transmission.
- Ideal for workshop pits due to low minimum height and long stroke
- Pedal operated pump with built-in quick lift leaving both hands free for working

### Specifications:

Lifting Range 905-1,920mm

VLT12



**\$2,835**



## 0.5 Ton Hydraulic Wheel Trolley

Ideal for lifting wheels on vans, trucks, and buses as well as brake drums, fuel tanks, toolboxes etc.

### Features:

- Flexible and ergonomic wheel trolley for the easy removal
- Lifting arms with roller bearings for easy rotation
- Pedal operated pump leaving both hands free for working

### Specifications:

Wheel Size Ø 270-1,300mm

WTA500



**\$2,774**



## Hydraulic Wheel Trolley with Handle and Wheel Rotation 20 Tonne

### Features:

- Two robust handles for easy maneuverability
- A handle facilitates easy turning of the wheel on the trolley
- The wheel can be secured with a ratchet strap for maximum safety

### Specifications:

Wheel Size Ø 1,000-2,400mm (Minimum-Maximum)

Wheel Width 1,200mm (Maximum)

WT1500NT



**\$5,821**

OR \$32 PW\* SEE PAGE 30 FOR FINANCE DETAILS.



## 20 Tonne Twin Ram Pit Jack Large Cradle

### Features:

- 2 individually controlled rams offer safe and balanced lifting
- Rapid and precise air hydraulic unit with high speed ram travel
- Simple modern design with control panel at an ergonomical working height
- Transversely sliding rams
- Can be made to fit all pits due to its adjustable frame
- Frame height is adjusted and set to the customers individual specifications
- Comprehensive option range: cross beam, support bridge etc.
- Supplied with 2x 100mm extensions

GD2002L



**\$7,849**

OR \$43 PW\* SEE PAGE 30 FOR FINANCE DETAILS.



## Air Hydraulic Pit Jack with Traversing Telescopic Cylinder 15/15 Ton

### Features:

- Flexible pit jack for use in pit or under a lift
- Traversing cylinder ensures a wide reach under the vehicle and enables movement freely back and forth
- Ideal for remounting of gearboxes
- Spring loaded wheel supports prevent unintended movements when lifting more than 800kg

### Specifications:

Lifting Range 920-2,205mm

GGD150U



**\$9,665**

OR \$53 PW\* SEE PAGE 30 FOR FINANCE DETAILS.



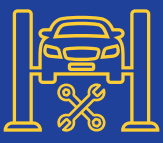

# HEAVY DUTY LIFTING

## 8.5 Tonne Mobile Truck Column Lifts

### Features:

- Reliable hydraulic technology
- Adjustable pick-up forks
- Adjustable lowering speed
- Simple re-charging
- Fast lifting and lowering
- Easy to move
- Safe working space
- Unique synchronisation
- Fast, efficient, and reliable

For operating the mobile column lifts, Stertil-Koni offers for both Wireless and Cabled models the eBright Smart Control System:

- Wireless, eBright Smart Control System (FWA)
- Cabled, eBright Smart Control System (FSA)

### Specifications:

Lifting Capacity	8.5 Tonne
Lift System	Hydraulic lifting system with microprocessor controlled synchronisation
Lifting Height	1,850mm (Maximum), automatic stop at the highest position
Lifting Time	Approx. 94 Seconds
Motor Rating	3.0kW per column
Weight	615kg per column
Column Lift Height	2,465mm (97.04")

ST1085EB

# \$12,400 PER COLUMN

OR \$68 PW\* SEE PAGE 30 FOR FINANCE DETAILS.

Optional Accessories		
39226625	8,500kg Axle Stand	\$1,275
STERILCABLE	IEC Cable 2 into 1	\$115



stertil KONI

EXCLUSIVE!

## Wireless Mobile Column Lifts 7.5 Tonne

### Features:

- Electro/hydraulic drive per column
- Double automatic load securing with hydraulic check valve and mechanical locks
- A switch on the master column for single or four column operations
- Waterproof for outdoor use
- Automatic synchronizing control
- Wheels for easy maneuverability around the workshop
- ALI tested & Certified (the toughest independent USA testing lab for hoists)
- CE Certificate & TUV
- 12 Month Warranty

### Specifications:

Lifting Capacity	7,500kg per column
Pairing Capability	Up to 16 columns Wireless
Lifting Time	Approx. 120 Seconds (full height)
Lifting Stroke	1,700mm
Weight Per Column	650kg
Pick Up Forks	500-1,120mm

FC75W

# \$8,606 PER COLUMN

OR \$47 PW\* SEE PAGE 30 FOR FINANCE DETAILS.

### Optional Accessory

ASA	7.5 Tonne Axle Stand	\$749
-----	----------------------	-------



MAXIMA  
Advanced Repair Systems

EXCLUSIVE!

## SKYLIFT - Superior Platform Vehicle Lifts with Unique Freedom Of Movement

### Safe, Ergonomic and Easy to Operate

The design of the SKYLIFT offers workshop staff maximum working space and accessibility. With 4 independent Y-shaped member construction supports, the floor is almost completely free during lifting. There are no cross beams, scissors or columns obstructing access to the elevated vehicle so the mechanic can work ergonomically and very safely, standing upright under the vehicle. Toolboxes and other workshop equipment can easily be maneuvered under the platforms as there are no obstacles or hurdles on the workshop floor.

### Safety Features:

- Precision independent mechanical locking and an overload protection system. Locking starts at only 90mm from floor level
- Above ALI standards testing 20,000 lifting cycles at maximum load
- The unique "Y-shaped" patented construction supports makes the SKYLIFT extremely robust and stable
- Automatic overload protection system safeguards against overloading or uncontrolled descent
- Safety measuring system constantly monitors and adjusts the position of all individual supports during operation
- Low voltage control system
- Reliable and strong Stertil-Koni hydraulics system
- Anti-slip plates to prevent vehicle movement

### Intuitive eBright Control System:

The SKYLIFT has a 7" full colour touchscreen and provides intuitive user-friendly visual information. The eBright allows two lifts in tandem configuration to be operated at the same time. The control console houses the power and operations unit and has easy access for maintenance and inspection. It is fitted with a self-diagnostic system in the event of a power failure, allowing for manual operation.

### Maximum Versatility:

- Lifting capacity from 20,000-70,000kg
- Various platform lengths from 7-30 meters
- Flexible platform width configurations which can be determined during installation
- Construction with an even distribution of horizontal forces and reduction in floor load, reducing wear to workshop floor
- No floor base frame required
- In tandem configuration

41405000 - 25 Tonne 10m SKYLIFT

41406000 - 25 Tonne 12m SKYLIFT

# POA



stertil KONI

EXCLUSIVE!

## 12 Tonne 4 Post Truck Lift 10 Metre

### Features:

- The operational unit containing the control box and hydraulic pump can be positioned on each post for easy operation, maintenance and inspection
- Durability and reliability
- Stertil-Koni are technological leaders in hydraulic heavy duty vehicle lifting systems. This is incorporated in the ST4120. The fewer moving parts the better as this reduces the risk of defects and expensive repairs, being required
- Electronic synchronization system that continuously monitors the position of all cylinders creating safe, smooth and level lifting and lowering
- Robust and reliable Stertil-Koni hydraulics with pressure relief and hose burst valves
- Independent gravity operated locking mechanism to prevent unexpected lowering
- Tandem configuration for longer vehicles
- ST4120 can be extended in a tandem configuration with two lifts in line which can be operated individually or together. Perfect for long buses or other longer combinations
- ANSI/ALI-ALCTV certified (USA)
- CSA certified (Canada)
- CE certified (Europe)
- Low voltage control cabinet
- Automatic overload protection
- Independent mechanical locking system
- Microprocessor-controlled tracking system
- Automatic stop when highest position is reached
- Dead-man's operation
- Automatic Overload Protection
- Independent Mechanical Locking System
- Automatic top when highest position is reached
- Dead-man's operation
- Splash-proof electrical system (IP65)

### Specifications:

Lifting Capacity	12 Tonne
Platform Length	10m (32.8")
Lifting System	Hydraulic
Lifting Height	74.1/2" (1,890mm)
Lifting Time	Approx. 90 Seconds
Motor	1x7.5 HP (5.5kW)

41004000

# POA



stertil KONI

EXCLUSIVE!

# ASK US ABOUT DELIVERY & MECHANICAL INSTALLATION





## 4 Post 13.6 Tonne Heavy Duty Hoist

### Features:

- 13.6 Tonne lifting capacity
- Extra Long
- Single piece columns
- Heavy duty high-performance cable and sheave system
- Single point one button air operated lock release
- Internal airline kit
- Multi-position lock components
- Automatic ramp chocks with floor protection
- Hydraulic cylinder and lift mechanism under runway
- Durable powder coated finish
- Design registered for Australia and New Zealand

### Specifications:

Overall Length	9,690mm (Including ramps)
Overall Width	3,813mm (Including motor)
Column Inside Width	3,382mm
Height of Columns	2,153mm
Maximum Lifting Height	1,746mm
Maximum Wheelbase	7,797mm
Width of Runways	610mm
Width Between Runways	1,067/1,219mm
Rise Time at Rated Capacity	Approx. 105 Seconds
3 Phase 415V	

### CR30EL

3 Phase unit includes Thermal Overload/Isolation switch as standard

# \$41,500

OR \$57 PW\* SEE PAGE 30 FOR FINANCE DETAILS.



Shown with optional RJ151BK Jacking Beams

**EXCLUSIVE!**

**INCLUDES  
2 YEAR  
WARRANTY**

**EXTRA  
LONG**



## 4 Post 8.1 Tonne Heavy Duty Hoist

### Features:

- 8.1 Tonne lifting capacity
- Extra Long
- Single piece columns
- Multi-position lock components
- Non-skid surface on runways
- Automatic ramp chocks with floor protection
- Hydraulic cylinder and lift mechanism under runway
- Durable powder coated finish
- Design registered for Australia and New Zealand

### Specifications:

Overall Length	7,904mm (Including ramps)
Overall Width	3,498mm (Including motor)
Column Inside Width	3,098mm
Height of Columns	1,975mm
Maximum Lifting Height	1,727mm
Maximum Wheelbase	5,842mm
Width of Runways	559mm
Width Between Runways	1,092/1,168mm
Rise Time at Rated Capacity	Approx. 105 Seconds
3 Phase 415V	

### CR18EL

3 Phase unit includes Thermal Overload/Isolation switch as standard

# \$22,780

OR \$126 PW\* SEE PAGE 30 FOR FINANCE DETAILS.



**EXCLUSIVE!**

**INCLUDES  
2 YEAR  
WARRANTY**

**EXTRA  
LONG**



### Optional Accessories

RJ9100Y-BK	4 Tonne Jacking Beam Rolling	\$4,825 OR \$27 PW* SEE PAGE 30
S100138B	Bolt on Wheel Alignment Deck Kit	\$6,280 OR \$35 PW* SEE PAGE 30

# ASK US ABOUT DELIVERY & MECHANICAL INSTALLATION



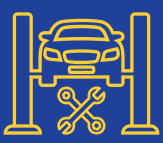

# VEHICLE LIFTING

## Commercial Grade 4,000kg Hoist

### Features:

- Quality commercial grade hoist - designed to our own requirements
- 3,750mm overall height
- Padded height protection limit switch
- Safety locks with single point release on control post
- Double telescopic lifting pads
- 100mm 4x4 adapters included as standard
- Automatic arm locks
- Single and three phase available
- Single phase for the widest range of applications

**CEN-4000B**

# \$5,525

OR \$30 PW\* SEE PAGE 30 FOR FINANCE DETAILS.



**CENTURY** »  
AUTOMOTIVE EQUIPMENT

## Professional Series 4,500kg Hoist

### Features:

- High Top as standard
- Heavy duty hoist, designed for high demand environments such as dealerships and busy workshops
- Padded height protection limit switch
- Automatic safety locks, with lock button on control box ensuring operators always sit the hoists on the locks
- 220V power point on control box for running tools
- Double telescopic lifting pads.
- 100mm 4x4 adapters included as standard
- Extra wide opening arms for vehicle manoeuvring
- Automatic arm locks
- Single and three phase available

### Specifications:

Overall Height	4,000mm
Lifting Capacity	4,500kg
Lifting Time	Approx. 35 Seconds (415V)

**CEN-2PKS-45**

# \$6,525

OR \$36 PW\* SEE PAGE 30 FOR FINANCE DETAILS.



**CENTURY** »  
AUTOMOTIVE EQUIPMENT

## Commercial Flat Platform 4,000kg Lift

### Features:

- 1x 2,000kg rolling jack as standard
- Electric locks, jacking beams are air operated with internal air lines (connection on control post)
- High resistance galvanized and pre-stretched lifting cable
- Extended hanging ramps for low vehicles
- Automatic spring loaded eccentric brake system in the event of cable breakage and ensures complete stability during parking
- Self lubricated large diameter pulleys and maintenance-free bushes
- Air lines pre-run through hoist for jacking beams with regulator mounted on control post
- Optional 2nd 2,000kg rolling jack

### Specifications:

Maximum Lifting Height	1,770mm (Body) 455mm (Jack)
Lifting Capacity	4,000kg (Body) 2,000kg (Jack)
Dimensions	5,595 x 3,095 x 2,255mm (LxWxH)

**CEN-4PK-4000/1**

# \$11,249

OR \$62 PW\* SEE PAGE 30 FOR FINANCE DETAILS.



**CENTURY** »  
AUTOMOTIVE EQUIPMENT

## Professional Wheel Alignment 5,000kg Hoist

### Features:

- 1x 3,000kg rolling jack as standard
- Electro-hydraulic jacking beams with remote
- Extended ramps, rear slip plates and front turntable recesses
- No air supply needed to hoist
- Korean design and power pack
- High resistance galvanized and pre-stretched lifting cable. Adjustable parking locks for perfect alignments
- Extended hanging ramps for low vehicles
- Automatic spring loaded eccentric brake system in the event of cable breakage and ensures complete stability during parking
- Self lubricated large diameter pulleys and maintenance-free bushes with grease points
- Electric remote control to operate jacking beams and hoist. (Runs along cable between posts)
- Optional 2nd 3,000kg rolling jack

### Specifications:

Maximum Lifting Height	1,750mm (Body) 455mm (Jack)
Lifting Capacity	5,000kg (Body) 3,000kg (Jack)
Dimensions	5,944 x 3,095 x 2,185mm (LxWxH)

**CEN-4PKA-5000/1**

# \$14,525

OR \$80 PW\* SEE PAGE 30 FOR FINANCE DETAILS.



**CENTURY** »  
AUTOMOTIVE EQUIPMENT

## ASK US ABOUT DELIVERY & MECHANICAL INSTALLATION







## 3.3 Tonne Full Rise Scissor Lift

### Features:

- Adjustable extension ramp
- Available as either on-ground or in-ground installation
- Extra low profile version
- Mechanical locking device

### Specifications:

Lifting Capacity	3,300kg
Lifting Range	140-1,953mm (Minimum-Maximum)
Dimensions	3,841 x 2,065 x 140mm
Power Supply	1ph: 2.5HP, 4P, 240V, 60 Hz 3ph: 2HP, 4P, 415V, 50/60 Hz

HL32X

# \$11,525

OR \$64 PW\* SEE PAGE 30 FOR FINANCE DETAILS.



## 4 Tonne Wheel Alignment Scissor Hoist

### Includes:

- Includes 1x 2,000kg jacking beam, Remote control and lighting kit
- Optional 2nd 2,000kg jacking beam

### Specifications:

Lifting Capacity	4 Tonne
Lifting Height	1,640mm (Maximum)
Lifting Time	Approx. 65 Seconds
Overall Length	5,945mm
Runway Length	4,500mm
Overall Floor Width	2,150mm
Runway Height	260mm
Power Supply	3 Phase Only

HL53X

# \$22,950

OR \$127 PW\* SEE PAGE 30 FOR FINANCE DETAILS.



\*Second optional jacking beam shown

## 4 Post 4.5 Tonne Wheel Alignment Hoist

### Includes:

- 1x 2,500kg Jacking Beams
- Wheel alignment kit with Rear Slip Plates
- Electric remote control

### Specifications:

Lifting Capacity	4.5 Tonne
Lifting Height	1,740mm (Maximum)
Lifting Time	Approx. 60 Seconds
Overall Length	5,860mm
Runway Length	4,510mm
Overall Floor Width	3,425mm
Runway Height	174mm
Power Supply	3 Phase Only

HL42L-A

# \$19,195

OR \$100 PW\* SEE PAGE 30 FOR FINANCE DETAILS.



Shown with optional Work step and Turn plates. Shown with 2 jacking beams, but is only supplied with 1.

## 2 Post 4 Tonne Clear Floor Hoist

### Specifications:

Lifting Capacity	4 Tonne
Lifting Range	124-1,924mm (Minimum-Maximum)
Lifting Time	40-60 Seconds
Motor	2hp 3 Phase
Optional 240V available	

HL26K

# \$8,545

OR \$53 PW\* SEE PAGE 30 FOR FINANCE DETAILS.

### Also Available

HL26K-H	HL26K with Height Extension	\$9,525 OR \$53 PW* SEE PAGE 30
---------	-----------------------------	---------------------------------



## 2 Post 6 Tonne Clear Floor Hoist

### Features:

- Automatic arm restraints
- Ram type cylinder and synchronisation wire rope
- Double telescope screw pads
- Adjustable cross member height
- High quality industrial ram type cylinders ensure max longevity

### Specifications:

Lifting Capacity	6 Tonne
Lifting Height	1,924-2,032mm (Maximum)
Dimensions	3,028 x 3,620 x 4,448mm (LxWxH)
Motor	3 Phase: 3HP, 4P, 415V 50/50Hz

HL27M

# \$9,721

OR \$54 PW\* SEE PAGE 30 FOR FINANCE DETAILS.



# ASK US ABOUT DELIVERY & MECHANICAL INSTALLATION



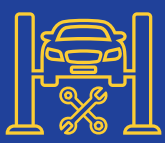

# VEHICLE LIFTING

## 2 Post 4.5 Tonne Hoist

### Features:

- 4.5 Tonne lifting capacity
- Symmetrical single piece columns
- Spot-Rite™ 3-stage front arm design
- Symmetric or asymmetric lifting
- Top mounted direct-pull dual hydraulic cylinders
- Cylinder rod concealed inside the carriage
- Standard or wide installation
- Foam padded safety overhead cut-out bar
- 90mm lift pad adaptor
- Single point lock release
- Durable powder coated finish
- 4x Rubber door bumper kit and round screw-up lift pads
- Design registered for Australia and New Zealand

I10 - Blue

3 Phase unit includes Thermal Overload/Isolation switch as standard

# \$7,200

OR \$40 PW\* SEE PAGE 30 FOR FINANCE DETAILS.

### Specifications:

Overall Height 3,632mm  
 Overall Width 3,327mm or 3,480mm  
 Drive Through Clearance 2,515mm or 2,667mm  
 Column Inside Width 2,756mm or 2,908mm  
 Overhead Switch Height 1,130mm  
 Front Reach 584/1,127mm  
 Rear Reach 978/1,473mm  
 Minimum Pad Height 95mm  
 Maximum Lifting Height 1,934mm with Extension  
 1,807mm without Extension  
 3,658mm

Required Ceiling Height  
 Rise Time at Rated Capacity  
 3 Phase 415V  
 Approx. 45 Seconds



**EXCLUSIVE!**

**INCLUDES  
2 YEAR  
WARRANTY**

**SINGLE  
PIECE  
COLUMN**

### Also Available

I10-240V	Single Phase 240 Volt in Blue	\$7,200 OR \$40 PW* SEE PAGE 30
I10-RED	3 Phase 415 Volt in Red	\$7,200 OR \$40 PW* SEE PAGE 30
I10-240V-RED	Single Phase 240 Volt in Red	\$7,200 OR \$40 PW* SEE PAGE 30



## 2 Post 5.4 Tonne Hoist

### Features:

- 5.4 Tonne lifting capacity
- Full stroke hydraulic cylinders in each column
- Cylinder rod concealed inside carriage
- 3 Stage arm design
- Overhead cable equalization
- Standard or wide installation
- Spring operated arm restraints, disengage at floor level
- Foam padded safety overhead cut-out bar
- Single point lock release
- Durable powder coated finish
- Rubber door bumper kit
- Design registered for Australia and New Zealand

I12 - Blue

3 Phase unit includes Thermal Overload/Isolation switch as standard

# \$10,450

OR \$58 PW\* SEE PAGE 30 FOR FINANCE DETAILS.

### Specifications:

Overall Height 4,216mm  
 Overall Width 3,556mm or 3,708mm  
 Clearance 2,610mm or 2,762mm  
 Column Inside Width 2,918mm or 3,070mm  
 Overhead Switch Height 4,067mm  
 Front Reach 705/1,460mm  
 Rear Reach 705/1,460mm  
 Minimum Pad Height 121mm  
 Maximum Lifting Height 2,051mm with Extension  
 1,924mm without Extension  
 4,400mm

Required Ceiling Height  
 Rise Time at Rated Capacity  
 3 Phase 415V  
 Approx. 60 Seconds



**EXCLUSIVE!**

**INCLUDES  
2 YEAR  
WARRANTY**

### Also Available

I12-240V	Single Phase 240 Volt	\$10,450 OR \$58 PW* SEE PAGE 30
----------	-----------------------	----------------------------------



## 2 Post 4 Tonne Hoist

### Features:

- 4 Tonne lifting capacity
- Commercial grade
- Self-setting lock release
- Single point lock release
- Padded shut-off bar
- Asymmetric arm design
- Symmetric post design
- Durable powder coated finish
- Design registered for Australia and New Zealand

DL9

3 Phase unit includes Thermal Overload/Isolation switch as standard

# \$4,200

OR \$23 PW\* SEE PAGE 30 FOR FINANCE DETAILS.

### Specifications:

Overall Height 3,607mm  
 Overall Width 3,327mm  
 Clearance 2,292mm  
 Column Inside Width 2,769mm  
 Minimum Pad Height 93mm  
 Maximum Lift Height 1,946mm with Extension  
 1,819mm without Extension  
 3,658mm

Required Ceiling Height  
 Rise Time at Rated Capacity  
 3 Phase 415V  
 51 Seconds



**EXCLUSIVE!**

### Also Available

DL9-240V	240 Volt	\$4,200 OR \$23 PW* SEE PAGE 30
----------	----------	---------------------------------

Direct-Lift

# ASK US ABOUT DELIVERY & MECHANICAL INSTALLATION



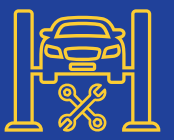

## 5 Tonne Wheel Alignment Scissor Hoist

### Features:

- Open front and rear
- Long rear slip plates
- Automatic rear wheel chocks engage when the lift is raised
- Mechanical locks automatically engage and pneumatically release
- High vertical rise of 1,882mm
- 625mm wide runways create a greater drive on area
- Master/slave hydraulic system
- All pivot points are made with self-lubricating bushings for long life
- Base plate levelling system for easy installation

### Specifications:

Runway Length	4,836mm
Lowered Height	292mm
Maximum Rise	1,882mm
Overall Length	6,500mm
Overall Width	2,276mm
3 Phase 415V	

FSA11

# \$27,000

OR \$149 PW\* SEE PAGE 30 FOR FINANCE DETAILS.



### Optional Accessories

LK-XA10-4	Lighting Kit	\$1,475
ALK-NBS40-2	Internal Airline Kit	\$1,300
RRJ71G	3.1 Tonne Rolling Jacking Beam	\$3,030 OR \$17 PW* SEE PAGE 30



**EXCLUSIVE!**

**INCLUDES  
2 YEAR  
WARRANTY**

## 6.3 Tonne Wheel Alignment Scissor Hoist

### Features:

- Open front & rear
- Heavy duty design
- Oversized air actuated rear slip plates
- 2x 3.1 Tonne jacking beam
- Front turn tables (pair)
- Simplified control unit
- Robust hydraulic system
- 14 locking positions
- Automatic rear wheel chocks
- Platform front wheel stops
- Base plate levelling system
- Self-lubricating bushings in pivot points
- ALI gold certified lift
- Made in Italy

### Specifications:

Runway Length	5,486mm
Maximum Wheelbase	5,029mm
Space Between Platforms	1,016mm
Runway Width	647mm
Maximum Rise	1,850mm
Minimum Lowered Height	273mm
Overall Length	7,035mm
Overall Width	2,311mm
3 Phase 415V	

FSA14

# \$46,700

OR \$257 PW\* SEE PAGE 30 FOR FINANCE DETAILS.



### Optional Accessory

LK-XA10-4	Lighting Kit	\$1,475
-----------	--------------	---------



**EXCLUSIVE!**

**INCLUDES  
2 YEAR  
WARRANTY**

## 4 Post 4 Tonne Hoist

### Features:

- 4 Tonne lifting capacity
- Single piece columns
- Automatic ramp chocks with silencer cushions
- Hydraulic cylinder and lift mechanism under runway
- Durable powder coated finish
- Design registered for Australia and New Zealand

### Specifications:

Overall Length	5,337mm (Including ramps)
Overall Width	3,276mm (Including motor)
Column Inside Width	2,718mm
Height of Columns	2,221mm
Maximum Lifting Height	1,962mm
Maximum Wheelbase	3,861mm
Width of Runways	508mm
Width Between Runways	1,000mm
Rise Time at Rated Capacity	Approx. 55 Seconds
3 Phase 415V	

CR4T - Blue

# \$9,500

OR \$52 PW\* SEE PAGE 30 FOR FINANCE DETAILS.

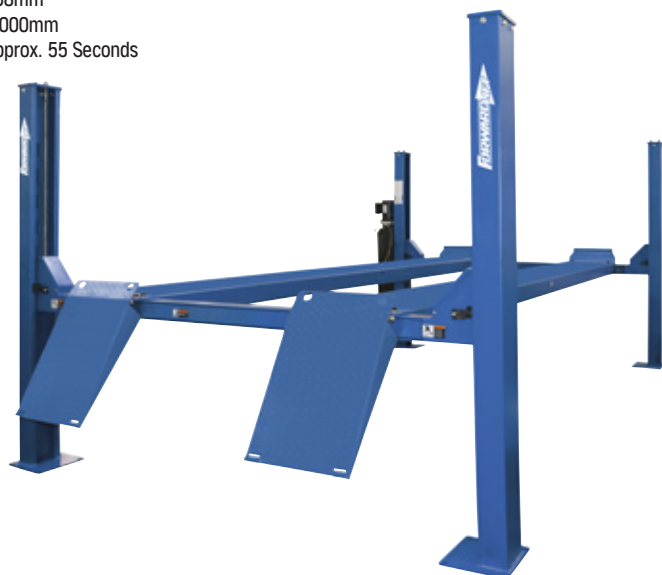

### Also Available

CR4T-GREY	3 Phase 415V - Grey	\$9,500 OR \$52 PW* SEE PAGE 30
CR4T-240V	Single Phase 240 Volt	\$9,500 OR \$52 PW* SEE PAGE 30

### Optional Accessories

NRJ45G-AP	2 Tonne Air/Hyd Jacking Beam	\$3,030 OR \$17 PW* SEE PAGE 30
RJ4500AP	2 Tonne Air/Hyd Jacking Beam	\$3,030 OR \$17 PW* SEE PAGE 30
AK4TBL	Bolt-on Wheel Alignment Deck Kit	\$3,580 OR \$20 PW* SEE PAGE 30



**EXCLUSIVE!**

**INCLUDES  
2 YEAR  
WARRANTY**

## CR14EL 6.3 Tonne Hoist & Two Jacking Beam Combo

### Features:

- Automatic ramp chocks with floor protection
- Heavy duty high-performance cable and sheaves system
- Hydraulic cylinder and lift mechanism under runway
- Durable powder coated finish

### Specifications:

Overall Length	7,188mm (Including ramps)
Overall Width	3,570mm (Including motor)
Column Inside Width	2,953mm
Height of Columns	2,299mm
Maximum Lifting Height	2,000mm
Maximum Wheelbase	5,461mm
Width of Runways	508mm
Width Between Runways	1,168mm
Rise Time at Rated Capacity	Approx. 72 Seconds
3 Phase 415V	

### COMBO DEAL

Includes 1x CR14EL, 2x RRJ71G Jacking Beams & 1x FC5760-14 Internal Air Line

# \$19,400

OR \$107 PW\* SEE PAGE 30 FOR FINANCE DETAILS.



### Single Unit Trade Price

CR14EL	Extra Long	\$15,585 OR \$86 PW* SEE PAGE 30
RRJ71G	3.1 Tonne Air/Hyd Jacking Beam	\$3,030 OR \$17 PW* SEE PAGE 30
FC5760-14	Internal Air Line Kit	\$850

### Optional Accessories

S100137M	Bolt on Alignment Kit for CR14EL	\$5,380 OR \$30 PW* SEE PAGE 30
FC5663Y	Work Step	\$699



**EXCLUSIVE!**

**EXTRA  
LONG**

# ASK US ABOUT DELIVERY & MECHANICAL INSTALLATION



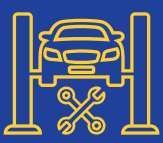

# WHEEL ALIGNMENT

## 3D HD Wheel Alignment

- The perfect balance of convenience, ease of use and quality
- High definition cameras height adjustable with manual controls
- Quarterly updates of the data bank for clear, rapid selection of different versions of vehicles
- Simple, intuitive graphics with rapid selection keys and icons
- Quick, precise measurements with value adjustments in real time
- Compact targets with no electronics and batteries

### Features:

- Cabinet
- Computer with WINDOWS 10 operating system
- 27" TFT monitor, colour printer, USB keyboard, mouse
- Four 4-point clamps, 12-24" with universal grips and targets
- Camera support with manual control
- Brake pedal lock, steering lock
- Wheel alignment software and database for CARS

DWA2500

# \$15,292

OR \$84 PW\* SEE PAGE 30 FOR FINANCE DETAILS.



+40,000 VEHICLES



## CEMB

## 3D HD Wheel Alignment for Cars and Light Trucks

- With movable camera automatically adjustable with lift height
- Frontal assistance video camera to help get onto the lift
- Wheel base, track and diagonal measurements to prevent damage from accidents
- Compact targets with no electronics and batteries

### Features:

- Cabinet
- Computer with WINDOWS 10 operating system
- 43" TFT monitor, colour printer, Wi-Fi keyboard, loudspeakers, front webcam, Wi-Fi pen drive
- Four 4-point clamps, 12-24" with universal grips and targets
- Camera support with manual control
- Brake pedal lock, steering lock
- Wheel alignment software and database for CARS

DWA3500

# \$19,985

OR \$110 PW\* SEE PAGE 30 FOR FINANCE DETAILS.



+40,000 VEHICLES



## CEMB

## Car Wheel Alignment - Complete Version

CCD sensor technology, featuring state-of-the-art electronic components enables a quick and accurate measurement of all alignment parameters by simply following a procedure field tested through many years of experience.

- More than 55,000 vehicles and is constantly updated
- New vehicle model ranking for fast selection
- MEMS accelerometer provides more stable and accurate data without being affected by shock sensitivity
- User friendly software
- AUDIT function can identify driving problems, App for remote control smartphone or tablet
- Optional CCD ADAS Kit for fast positioning of the vehicle before performing ADAS diagnostic servicing

DWA1100

# \$16,999

OR \$94 PW\* SEE PAGE 30 FOR FINANCE DETAILS.



## CEMB

## Argos Drivethru Contactless Wheel Alignment Inspection System

Brand new to NZ, this hi-tech reception lane provides a complete alignment check in seconds and gives any workshop the opportunity to significantly increase their profitability. Installing the ARGOS Drive thru allows ALL vehicles booked for service to have a free alignment test added to the service work requested. If an alignment issue is identified, you can sell the alignment service as added value. A typical workshop will likely see an increase of 500% in alignment jobs, simply by testing more vehicles and recommending the service.

- Full alignment check in seconds
- Complete and highly professional service
- Increases customer satisfaction and loyalty
- Minimum effort, maximum performance
- Clear and easy-to-understand diagnostic reports that can be shared directly via WhatsApp, SMS or Email

ARGOS Drive thru is extremely smart, simple and highly effective at increasing your value offer.

To see if this is something for your business call us for a consultation.

RGOSDT

# FROM \$41,075

OR \$227 PW\* SEE PAGE 30 FOR FINANCE DETAILS.



## CEMB



## 3D Wheel Alignment Systems V2260 & V2280 featuring our latest operating system

Now there's an advanced 3D imaging alignment system that doesn't require lots of training or experience to operate. With the proven XD target and camera system, the V2280 and V2260 features advanced technology, combined with the simplest, most intuitive software we've ever offered providing the essential tools for any alignment tech. It's the best of both worlds.

### Features:

- Software designed together with technicians around the core functions: you never wait for the system
- Cloud based reporting option: retrieve, print or send your reports from any internet connected PC or mobile device
- Intelligent and predictive alignment workflow for your selected vehicle without unnecessary steps
- Compensate, warn and interactions lets you perform your work fast with professional results
- Video speed cameras: constantly monitor the alignment
- Rolling compensation time reduced 35% compared to previous models
- Vehicle dimensions, cross diagonals, rolling radius, EZ Toe, EZ Access (wheels off)
- Automatic tracking camera beam on the V2280
- Manual movable camera beam on the V2260
- Flexible cabinet position - can be located anywhere in the bay
- Optional mobility base
- 1 Year of free specification updates
- 2 Years Warranty
- Manufactured in Italy

**EEWAEU543TH4** - V2260 Manual Movable Camera Beam - **\$26,900** OR \$148 PW\* SEE PAGE 30

**EEWAEU544TH4** - V2280 Automatic Tracking Camera Beam - **\$34,350** OR \$189 PW\* SEE PAGE 30

**FROM**  
**\$26,900**

OR \$148 PW\* SEE PAGE 30 FOR FINANCE DETAILS.



**EXCLUSIVE!**

JohnBean

## 3D Wheel Alignment System V2380 featuring our latest operating system

### Features:

- Integrated Operation Help
- OEM vehicle specifications (35+ years)
- 3D Animation Help
- ADAS information
- Save Print Reports to Cloud
- Network Updates for Software and Specs
- VODI™ - Vehicle Orientation Directional Indicator
- Remote Display Supported
- Automatic Lift Tracking
- Fastest rolling compensation and caster check
- Live Thrust Angle
- Live Caster, Camber and Toe - Turntables
- Live Caster, Camber and Toe - Elevated
- Toe Out on Turns and Maximum Turn
- Caster and SAI - Turntables
- EZ-Toe
- A-Arm Adjust and Live Cradle Adjustment
- Drag Link and Single Tie Rod Adjustment
- Live advanced vehicle dimensions
- Cross Diagonals and Rolling Radius
- Short bay installation
- AC400 No Rim Contact Mounting Clamps (grabs onto the tyre, without touching the rim)
- Audit Alignment Process (2 Machines in One)
- Optional mobility kit
- Optional AC100 H-Style Mounting Clamps
- 1 Year of free specification updates
- 2 Year Warranty
- Manufactured in Italy

**EEWAEU545TB4**

**\$36,900**

OR \$203 PW\* SEE PAGE 30 FOR FINANCE DETAILS.



**EXCLUSIVE!**

JohnBean



Rolling Radius



Advanced Vehicle Dimensions

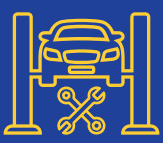

# WHEEL SERVICE

## Computerized Wheel Balancer

### Features:

- Automatic Offset & Diameter data entry
- Static, AL1, AL2 & AL3 balancing modules
- Wheel guard with automatic start function (Removable)
- Self diagnosis and self calibration
- LED wheel position indicator
- Foot pedal brake to stabilize tyres and position weights accurately
- Large flange and cone for balancing tyres, such as Transit, Iveco (Optional)

### Specifications:

Balancing Accuracy	+/- 1g
Rim Diameter	10-24"
Maximum Wheel Weight	65kg
Balancing Speed	200rpm
Cycle Time	8 Seconds

**CEN-425**

# \$2,699



**CENTURY** »  
AUTOMOTIVE EQUIPMENT

## Auto Data Entry LCD Wheel Balancer

### Features:

- Professional balancing for cars, lightweight truck, and vans
- Automatic data entry
- Automatic wheel positioning
- LED work-light and laser line
- Electronic input of wheel diameter and distance with QP Quick Program function: Automatically activated the balancing programs, avoiding keypad selection
- Low RPM balancing for reduced cycle time and increased lifespan
- Three modes to position the adhesive weights with the weight holder clip (optional), with the 6 o'clock laser indicator or manually at 12 o'clock
- One touch program for concealing counterweights behind spokes

**S63E**

# \$5,695

OR \$31 PW\* SEE PAGE 30  
FOR FINANCE DETAILS.

### Optional Accessory

<b>S63EAWD</b>	Automatic Wheel Width Measurement	<b>\$849</b>
----------------	-----------------------------------	--------------



**SICE**  
AUTOMOTIVE EQUIPMENT

MADE IN ITALY

## Tyre Changer 11-24"

### Features:

- Pneumatic tilting post controlled by foot pedal
- One touch locking of demount head vertical / horizontal position
- Foot pedal assembly is made of high quality steel
- Alloy clamping jaws, designed to be easily replaced when worn out
- Dismounting head is made of stainless steel, with plastic inserts for protecting the rim

### Specifications:

Dismounting	11-26" Rims
Maximum Tyre Diameter	1,143mm
Maximum Tyre Width	355mm
Single & 3 Phase Available	

**CEN-990**

# \$3,295

OR \$18 PW\* SEE PAGE 30  
FOR FINANCE DETAILS.

### Also Available

<b>CEN-990HA</b>	Tyre Changer w/ Helper Arm & Bead Blaster	<b>\$4,795</b> OR \$26 PW* SEE PAGE 30
------------------	---	--



**CENTURY** »  
AUTOMOTIVE EQUIPMENT

### Optional Accessory

<b>CEN-HF200</b>	Helper Arm for CEN990	<b>\$1,500</b>
------------------	-----------------------	----------------

## Professional Tilt-Back Tyre Changer

### Features:

- Tilt-back tyre changer with CE quick tyre inflation system
- Side patented demount head design
- Simultaneous pneumatic horizontal and vertical arm locking
- Self-centering jaws with two clamping cylinders
- Powerful 31KN bead braker with dual-adjustable blade and enlarged wheel pad
- Bead braker stroke limiter
- Front extractable pedal assembly
- 220V variable speed moto-invertor

### Specifications:

Outside Clamping	12-24"
Inside Clamping	14-27"

**S43 GP**

# \$8,295

OR \$46 PW\* SEE PAGE 30  
FOR FINANCE DETAILS.

### Optional Accessory

<b>PT 230</b>	Helper Arm for S43 GP	<b>\$2,899</b>
---------------	-----------------------	----------------



**SICE**  
AUTOMOTIVE EQUIPMENT

MADE IN ITALY

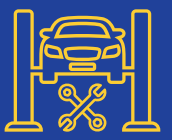

## B300L Wheel Balancer with Laser Guidance

The wheel balancer for tyre shops, car dealerships and garages with intuitive display in the weight tray.

### Features:

- Patented VPI measurement technique for uncompromised accuracy
- Pinpoint 5 o'clock laser to accurately position adhesive weights first time
- Semi-automatic input of offset and rim diameter via 2D Gauge arm
- Automatic non-contact rim width acquisition via Smart Sonar
- Automatic pre-selection of balancing mode
- Hide adhesive weights behind spokes so not to be seen
- Manufactured in Italy

### Specifications:

Reduced Measurement Time	4.5 Seconds (15" Rim)
Shaft Diameter	40mm
Maximum Rim Diameter	32"
Maximum Rim Width	20"
Maximum Tyre Diameter	42"
Maximum Tyre Weight	70kg

EEWB573AE1

# \$7,525

OR \$41 PW\* SEE PAGE 30 FOR FINANCE DETAILS.



**EXCLUSIVE!**

JohnBean

### Optional Accessory

EAK0306G66A Universal Wheel Lifter **\$2,050**

## B600P Wheel Balancer with Power Clamp

### Features:

- New touchscreen, user-friendly interface on a flat panel, resistive touch display
- VPI Measurement Technique
- The B600 series comes with the patented virtual plan imaging (VPI) technique which ensures accurate balancing results, while being insensitive to ambient conditions
- The Smart Sonar automatically detects rim width and the measuring run is started as soon as the wheel guard has been completely lowered 30% time savings compared to manual input
- The patented electro-mechanical power clamp always clamps the wheel accurately with a constant force, which is most important for every balancing operation
- easyWEIGHT
- Pinpoint indicator light - the accurate, fast and easy solution to position adhesive weight on the wheel

### Specifications:

Shaft Diameter	40mm
Measuring Speed	200rpm
Balancing Accuracy	1g/0.7°
Rim Diameter (Manual)	8-32"
Rim Diameter (Semi Automatic)	20"
Rim Width (Smart Sonar)	3-15"
Maximum Wheel Width	20"
Maximum Wheel Diameter	42"

EEWB576APE1

# \$12,000

OR \$66 PW\* SEE PAGE 30 FOR FINANCE DETAILS.



**EXCLUSIVE!**

JohnBean

### Optional Accessory

EAK0306G66A Universal Wheel Lifter **\$2,050**

## T5345T 24" Tilt-Back Tyre Changer with Helper Arm

### Features:

- MH 320 PRO Helper arm
- Under table inflation
- PROSpeed self-adjustable speed system;
  - Automatic speed control
  - First speed as low as 7rpm
  - Second speed auto-adjusts between 7 and 18rpm
- Double-acting bead breaker cylinder
- Pedal operated pneumatic tilt-back post
- Post pneumatically locked in working position
- Pedal operated inflator
- Toolbox with integrated pressure gauge
- Optional: Plus Kit

### Specifications:

Inner Clamping Range	12-24"
Outer Clamping Range	10-24"
Maximum Wheel Width	330mm
Maximum Wheel Diameter	1,000mm
Compressed Air Supply	116-174psi
Single Phase 240 Volt 15 Amp	

EEWH572AEQ

# \$11,950

OR \$66 PW\* SEE PAGE 30 FOR FINANCE DETAILS.



**EXCLUSIVE!**



JohnBean

### Optional Accessory

EAK0279G89A Wheel Lifter for T5345T **\$2,350**  
 HOF04030564 Plus Kit for JBC Tyre Changer **\$2,050**

## T6000T 26" Tilt-Back Tyre Changer with Helper Arm

### Features:

- MH 320 PRO Helper arm
- Under table inflation
- PROSpeed self-adjustable speed system;
  - Automatic speed control
  - First speed as low as 7rpm
  - Second speed auto-adjusts between 7 and 18rpm
- Double-acting bead breaker cylinder
- Pedal operated pneumatic tilt-back post
- Post pneumatically locked in working position
- Pedal operated inflator
- Toolbox with integrated pressure gauge
- Optional: Plus Kit

### Specifications:

Inner Clamping Range	14-26"
Outer Clamping Range	12-26"
Maximum Wheel Width	430mm
Maximum Wheel Diameter	1,200mm
Compressed Air Supply	116-174psi
Single Phase 240 Volt 15 Amp	

EEWH529AER

# \$13,750

OR \$76 PW\* SEE PAGE 30 FOR FINANCE DETAILS.



**EXCLUSIVE!**



JohnBean

### Optional Accessory

EAK0279G87A Wheel Lifter for T6000T **\$2,350**  
 HOF04030564 Plus Kit for JBC Tyre Changer **\$2,050**

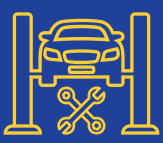

# WHEEL SERVICE

## Digital Wheel Balancer 3D

Fast and easy to use with Virtual Sonar technology giving immediate detection of parameters for any wheel up to 75kg, no manual data entry required. Balancing program selection depends on user preference with Auto Adaptive Mode and electromagnetic brake locking the wheel in exact weight position for higher accuracy correction.

- Clip on or stick on

ER10PRO

# \$5,055

OR \$28 PW\* SEE PAGE 30 FOR FINANCE DETAILS.



## CEMB



## Digital Wheel Balancer 3D with Laser Beam

Fast and easy to use with Virtual Sonar technology giving immediate detection of parameters for any wheel up to 75kg, no manual data entry required. Ergofast design give best possible working conditions with easy access to internal parts of the rim and all accessories are within reach. Balancing program selection depends on user preference with Auto Adaptive Mode and Laser Beam Guidance for fast and correct counterweight selection and positioning.

- Clip on or stick on

ER60PRO

# \$7,645

OR \$42 PW\* SEE PAGE 30 FOR FINANCE DETAILS.



## CEMB



## Entry Ergonomic Autoadaptive™ OPB Wheel Balancer

With fully automatic Spotter Laser System for best correction possible (no comebacks).

### Specifications:

Balancing Speed	Below 100rpm
Average Cycle Time	5 Seconds
Rim Width	up to 510mm (20")
Rim Diameter	up to 762mm (30")
Tyre Diameter	up to 1,067mm (42")
Max. Wheel Weight	75kg
Shaft Diameter	40mm (1.1/2")
Shipping Weight	168kg
Power	220V AC 50/60Hz 1-Phase

ER72TD

# \$9,995

OR \$55 PW\* SEE PAGE 30 FOR FINANCE DETAILS.



## CEMB



## Diagnostic Wheel Balancer

This top-of-the-range wheel balancer, in a matter of seconds automatically detects all wheel dimensions, unbalance, internal and external wheel and rim eccentricity, tread-depth and conicity without manual input or intervention.

- Twin laser beams for exact weight positioning
- Advanced diagnostic capabilities identify values of conicity, tread-depth, and eccentricity of the rim alone

### Specifications:

Balancing Speed	100rpm
Average Cycle Time	4.7 Seconds
Rim Width	up to 510mm (20")
Rim Diameter	up to 765mm (30")
Max. Wheel Weight	75kg

ER100EVO

# \$17,545

OR \$97 PW\* SEE PAGE 30 FOR FINANCE DETAILS.



## CEMB



## Tyre Repair Products Starter Pack

### Includes:

- Quick Fix M6 Maxiseal 6mm Box (6016)
- Spiral Cement Tool (915)
- Vulcanizing Fluid 235mL (760)
- Ball Bearing Stitcher 1/32 (938)
- Security Coat 470mL (738)
- Rub-O-Matic Aerosol 438mL (704A)

## COMBO DEAL

# \$150



Limit 1 Kit Per Customer.



## Tyre Repair Tools Starter Pack

### Includes:

- Rubber Scraper (933)
- Carbide Cutter 100mm Long (270)
- Contourcup Thread 36g MT42-186 (TCW210-36EXP)
- Gun Air Vacuum Kit (4195300K)
- Low Speed Buffer (S1032AC)
- Short Quick Change Arbor 13mm (S1046)

## COMBO DEAL

# \$431



Limit 1 Kit Per Customer.





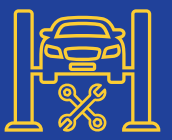

## Automatic Tyre Changer

Ideal for use in professional repair shops and tyre shops. Designed to operate on car and light commercial vehicle wheels. Supplied standard with the HP2 side presser, it allows easily and correctly operating on run-flat and UHP tyres up to 26".

- Rear tilting post and simultaneous hexagonal and horizontal arm locking system, vertical arm with spring return
- Self-centering plate with 12-26" locking capacity, double rotation and two speeds
- Body with extractable pedal unit to facilitate technical service, robust reduction unit, CE-certified inflation pressure limiter and pedal-driven inflation device. Supplied standard with a functional tool tray on the left-hand side
- Bead breaker with double-acting cylinder, articulated blade and adjustable bead breaker blade penetration stroke limiter

### Specifications:

Clamping Capacity	12-26"
Max Wheel Diameter	1,200mm
Max Wheel Width	340mm
Turntable Speed	6-12rpm
Machine Weight	355kg

### Models Available:

**JR645230** - Single Phase 240 Volt

**JR645415** - 3 Phase 415 Volt

# \$6,966

OR \$38 PW\* SEE PAGE 30  
FOR FINANCE DETAILS.



HP2

BACK

2 SPEEDS

**JRLINE**

**Butler**

MADE IN ITALY

## Passenger Automatic Tyre Changer

### Specifications:

Inner Clamping	12"/24.1/2"
Outer Clamping	10"/22"
Tool Working Span	8-24"
Maximum Wheel Diameter	1,050mm (41")
Bead Breaker Force	3,600kg
Electric Motor	230/400V, 50Hz, 0.8-1.1kW
Chuck Rotation Speed	6.5-13rpm
Maximum Torque Turntable	1,200Mn (885ft/lbs)

### HP641SD24FIPLUS

# \$13,495

OR \$74 PW\* SEE PAGE 30  
FOR FINANCE DETAILS.



## Speedplate EBA Pro System

Single Finger Plates for Wheel Balancers. Made in the USA.

### Features:

- Highly precise and maintains accuracy
- Extremely fast and easy to use
- Suitable for wheel balancers with a 40mm shaft (reducer sleeves available)

**E405-400-13** - 5 Stud Single Plate - **\$799**

**E406-400-13** - 6 Stud Single Plate - **\$850**

# FROM \$799



### Optional Accessory

**M140-818-10** Handle for Autoclamp Applications **\$250**

**vibrationsolutions**

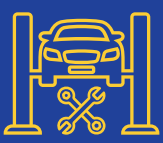

# WHEEL SERVICE

## Commercial Super Fast Truck Tyre Changer 14-24.5"

The Navigator 101 is a one-of-a-kind. Its uniqueness is in the operative system patented by Butler. It is equipped with four rollers with a unique form, positioned on the two sides of the wheel in diametrically opposite positions. With this system, the dismounting of the tyre with bead breakers is very simple and natural: while the anterior bead breakers keep the bead in the drop centre, the posterior ones continue their course until the dismounting is complete.

**Specifications:**

Chuckling Unit Rotation Motor	2
Hydraulic Drive Unit Motor	1, 5
Maximum Wheel Ø	52" (1,320mm)
Maximum Wheel Width	21.2" (540mm)
Weight	650kg
Bead Breaker Power	18,000N
Maximum Wheel Weight	1,200kgs/2,645lbs
Chuck Rotation Speed	8 (Rev/Min)
Maximum Torque to Chuck	2,600Nm

NAV101

# \$33,397

OR \$160 PW\* SEE PAGE 30 FOR FINANCE DETAILS.

**30 SECONDS:  
THE TIME YOU  
NEED TO  
DISMOUNT  
AND MOUNT A  
TRUCK TYRE**

**FASTEST  
IN THE  
WORLD**



## Truck Tyre Changer

- Universal tyre changer for trucks, buses and industrial vehicles
- Italian made
- Portable control stand for maximum control
- Tubed or tubeless wheels, with groove rim or with split ring rim
- Self centering chuck for 14-26" wheels
- Clockwise & Anti-clockwise rotation
- Hydraulic operated carriage left & right
- Powerful Bead Breaker up to 14,000N
- Electric motor with overload cut-out
- Pressure gauge and safety valves on hydraulic system
- Max Wheel Diameter: 1,400mm
- Max Wheel Width 695mm

S52A

# \$13,599

OR \$75 PW\* SEE PAGE 30 FOR FINANCE DETAILS.

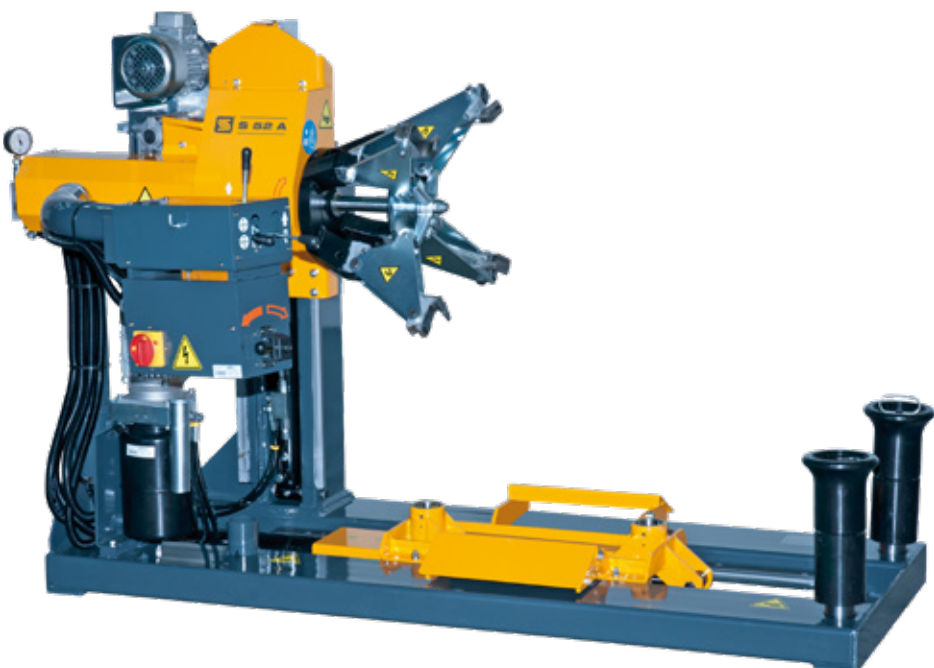

## Truck Wheel Balancer

CEMB balancer for truck wheels, heavy duty truck service shops, municipalities, fleet truck tire service companies and all commercial truck tires. CEMB's C212 comes fully assembled.

**Features:**

- C212 balances steel & light alloy wheels of cars, light & heavy commercial trucks and bus thanks to a 40mm shaft and a large assortment of adaptors and cones standard
- Pneumatic stationary brake useful during wheel mounting and counterweight application
- Pedal operated pneumatic lift (soft type) enables excellent centering accuracy of the wheel on the shaft
- Automatic Distance & Diameter Entry (2D)
- Fully Automatic Cycle with Breaking
- 51" Wheel Guard
- Self-Diagnosis and Self-Calibration
- Optimization program for compensation of rim and tire unbalance
- "Static" program-plus 4 ALU programs for PAX, light alloy or special shaped rims
- One Button Split & Hidden Weight Program
- Direct weight location program (no re-positioning of stick-on weights)

**Specifications:**

Power Supply	220V, 1ph, Air
Wheel Clamping Type	Manual
Maximum Rim Diameter	30" (765mm)
Maximum Rim Width	20" (510mm)
Maximum Tyre Diameter	51" (1,295mm)
Maximum Wheel Weight	550lbs (250kg)

C212

# \$11,195

OR \$62 PW\* SEE PAGE 30 FOR FINANCE DETAILS.





## 6.5HP 196cc Petrol Compressor with Champion Engine with 70L Tank

An ideal go anywhere petrol driven compressor that can be easily moved around or mounted to the flat deck of a service vehicle by removing the wheels. The powerful 196cc Kohler engine and 3 cylinder cast iron pump delivers 19.4 CFM of air to power most air tools.

**Specifications:**

Tank Capacity	70L
Air Displacement	550L/min (19.4 CFM)
Pressure	6-8 Bar (87-116psi)
Power	6.5HP, 196cc engine with recoil start
Free Speed	3,300rpm
Dimensions	1,150 x 450 x 780mm (LxWxH)

AFP6570

**\$2,007**



**EXCLUSIVE!**

## 7.5 HP Belt Driven Compressor with 300L Tank

MEPS 2 motor. Ball valves: 2pc. Soft start CE vertical pressure switch + magnetic starter.

**Specifications:**

Tank Capacity	300L
Air Displacement	885L/min (31 CFM)
Pressure	6-8 Bar (87-116psi)
Power	7.5HP
Free Speed	2,800rpm
Voltage/Frequency	415V/50Hz

AF38

**\$3,787**

OR \$19 PW\* SEE PAGE 30 FOR FINANCE DETAILS.



**EXCLUSIVE!**

## 3.0HP Piston Compressor

PR 100/3M, 3Hp, 2.2kW, 230V / 1ph - 100L Tank Compressor Pump: K 17 (K Series)

**Specifications:**

Tank Capacity	100L
Air Displacement	400L/min (14.1 CFM)
Free Speed	1,250rpm
Cylinders	2
Power	3HP (2.2kW)
Noise	75dB(A) Maximum
Voltage	230V / 1 Phase / 50Hz
Weight	73kg

PR100/3M

**\$1,634**



**EXCLUSIVE!**

## 4.0HP Piston Compressor

Compressor Piston PR 200/4T, 4.0HP, 3kW, 400V / 3ph - 200L Tank

**Specifications:**

Tank Capacity	200L
Air Displacement	540L/min (19.1 CFM)
Pressure	10 Bar (145psi)
Free Speed	1,100rpm
Cylinders	2
Power	4HP (3kW)
Voltage	400V / 3 Phase / 50Hz
Weight	96kg

PR200/4T

**\$2,057**



**EXCLUSIVE!**



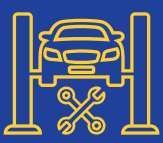

# BRAKE SERVICE

## On-Car Brake Lathe Package (X9 Series) High-Performance Expandable Platform

### Features:

- Rigid X-frame chassis
- Powerful belt driven high torque drivetrain
- Integrated super-bright LED light
- Patented one-touch lateral run-out compensation
- DRO live digital computer display
- One-piece mounting adaptors
- Cross platform compatibility
- Speed-lock cutting head
- Fast, but accurate at only 6-8 minutes per rotor
- Once the cut is initiated the technician can complete other work
- Approved by most OEMs

### Includes:

- X9 Series lathe with digital read out
- 4-wheel adjustable trolley with adaptors storage
- Australian adaptor package
- Comprehensive accessories package including silencers and cutting tips
- Including point-of-sale pack

### PFM X9

# \$16,750

OR \$92 PW\* SEE PAGE 30  
FOR FINANCE DETAILS.



**EXCLUSIVE!**

## Bench Brake Lathe Package

Switching from resurfacing brake discs to drums takes merely seconds with the P2 quick change cutting head. Feed direction is automatically changed as you spin and lock down the head with just one lever. The power plant of the B17 is a quiet DC motor which provides smooth operation across a wide range of discs and drums.

The B17 is equipped with our most advanced electronics package which tracks lathe usage and provides service reminders. All of that and it's mounted on a mobile tool cabinet to safely store all your necessary adaptors and accessories. You just can't beat the B17's quality, precision and innovation from the folks who perfected on-car lathes.

### Features:

- LED arbor light ring
- P2 quick change cutting head
- Mobile toolbox trolley
- Small, but powerful design
- Digital interface
- New generation electronics

### Includes:

- B-17 lathe with digital read out
- Mobile toolbox trolley with storage trays for accessories
- Quick chuck mounting kit
- Taper cone mounting kit
- Comprehensive accessories package including silencers and cutting tips

### PCB-17

# \$13,500

OR \$74 PW\* SEE PAGE 30  
FOR FINANCE DETAILS.

Includes quick chuck and taper cone mounting kit



**EXCLUSIVE!**



## Double-Thick Silencer/Chip Deflector 50-754

# \$80



## Standard Silencer/Chip Deflector 50-744

# \$80



## Premium Carbide Cutting Tips & Screw 10pc 50-742

# \$125



# STOCKTAKE SALE STOCKTAKE SALE STOCKTAKE

## On-the-Truck Disc Lathe

The TD 502 machine completely changes the concept of disc reconditioning in trucks and buses. No more time loss while disassembling the disc for bench turning. Now machining operations can be done directly on the hub. This revolutionary idea has led to the creation of a machine that minimizes the set-up time. It is mounted on a swinging and height-adjustable self-aligning saddle that always guarantees the perfect matching between the machine and the hub (with no need for further alignment or centering operations with a comparator).

### TD502

# \$6,000

OR \$33 PW\* SEE PAGE 30  
FOR FINANCE DETAILS.



**EXCLUSIVE!**



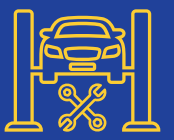

## BM3010 Brake Tester

Good brake maintenance is essential for the safety of everyone on the road. It reduces stopping distance, pulling of vehicle left or right under braking, and accidental failure in adverse conditions. In New Zealand this is especially important because of the types of road conditions we are faced with due to our unique terrain and vehicle fleet.

The importance of good brakes is so high, that NZ Police commissioned 6 BM Equipment mobile brake roller testers that are being deployed across NZ to randomly test our truck fleet for safety. But road safety also applies to passenger vehicles who share the same roads.

BM Equipment also manufactures several different models of roller brake testers for light vehicles. Models vary from mobile/on-ground to in-ground for both one bed and split bed installation. All models are based on the same X010 electronics and measuring system and have various read-out options including the BM FlexiCheck that sends test result to a PC, laptop, PDA or mobile phone for ease of result sharing/recording. The key to an accurate reading is slowing the speed of brake application. A gradual increase in pressure on the brake foot pedal provides a good assessment of braking performance across the entire braking force range to highlights any performance issues, imbalances and anomalies. With over 800 BM Equipment brake roller testers in operation in NZ already, choosing BM is a wise decision. If you are looking to add or replace an existing brake roller, give our equipment specialist team a call and arrange a free consultation. We have the knowledge, expertise and understanding of the NZ car parc to provide a tailor-made solution just right for you and your clients.

CD112009

# \$29,355

OR \$141 PW\* SEE PAGE 30 FOR FINANCE DETAILS.



BM3010 roller brake tester on-ground in front of workshop hoist

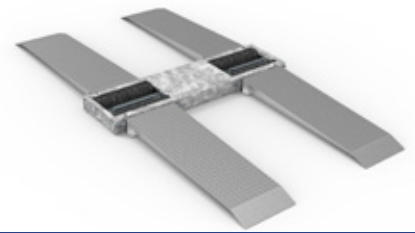

BM3010 roller brake tester on-ground – 3D animation



Test result display – can be column, wall or trolley mounted



BM FlexiCheck on smartphone and tablet

**BM**  
TEST EQUIPMENT  
- the safe choice

## BM20200 - Above Ground Mobile Truck Brake tester

The BM20200 roller brake tester is designed for direct on-ground installation without need of civil work. Can be retro fitted to existing pits or used for mobile roadside testing. It requires only approximately 10 minutes for one person to set it up for operation.

- Readout Options – Dial display (free standing or wall mounted) or PC control
- Axle Capacity: 13/20 tonne
- Optional automatic axle weighing and vehicle total weight
- Test of 4x4, 6x4 and 8x6 driven vehicles
- Optional cable or radio pedal force meter
- Optional cable or radio air/hydraulic pressure system

**Possibility to create a mobile test lane concept consisting of:**

- BM53000 mobile wheel play detector
- BM605 tachometer
- Optional axle load simulation

CD111015

# POA

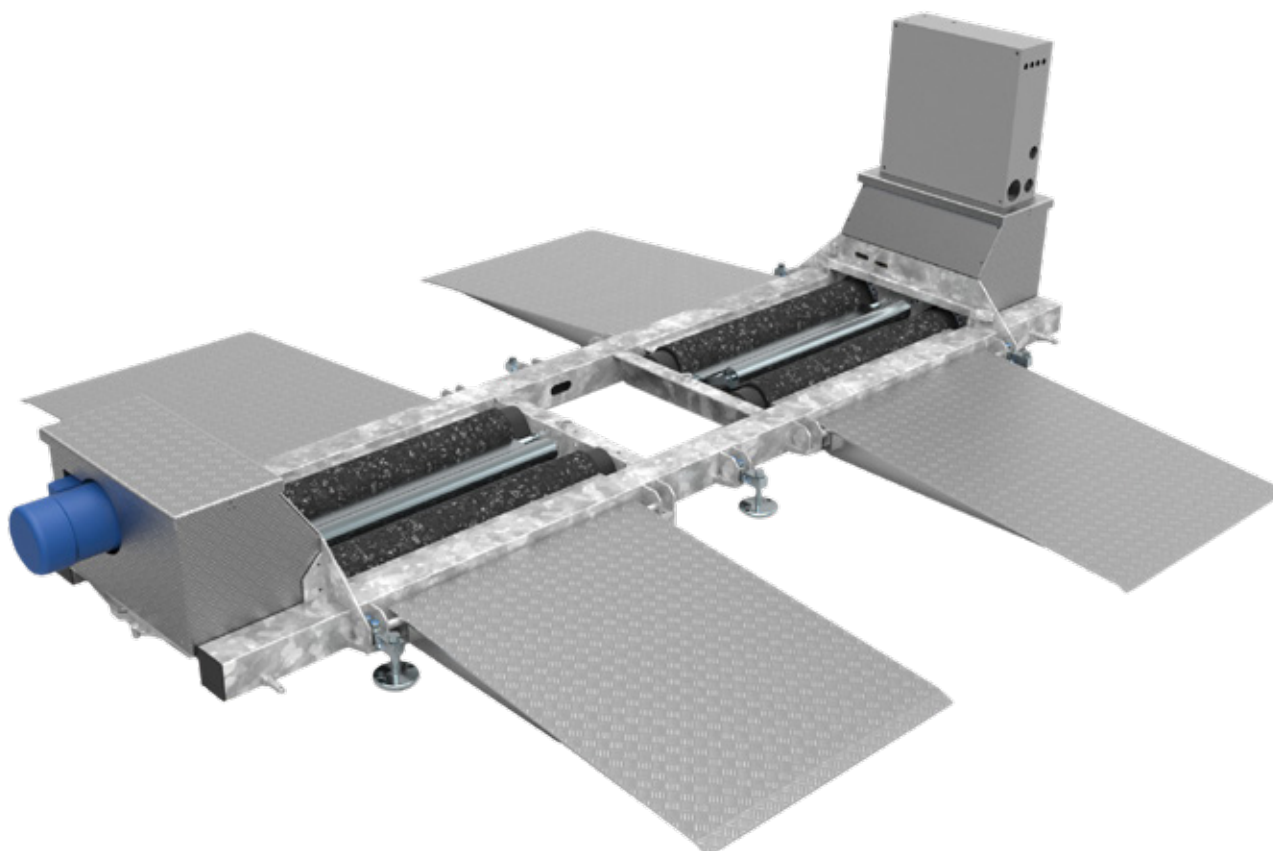

BM20200 installed in existing pit



BM20200 used for roadside testing



Dial display for testing equipment



BM FlexiCheck on smartphone and tablet

**BM**  
TEST EQUIPMENT  
- the safe choice

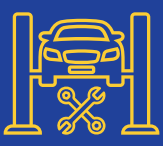

# CRC® PART WASHERS

## CRC SmartWasher® BIOREMEDIATING parts washing system

### SMARTER & SAFER SOLUTION

The CRC SmartWasher® is a manual parts washer that replaces traditional solvent or aqueous alternatives. It uses a non hazardous, non-flammable, water-based degreasing solution that offers a superior cleaning performance as powerful as solvents while being safer for the user.

#### MACHINES



#### MOBILE PARTS WASHER

CODE SW-23

- Most popular
- Light, mobile unit
- Push button brush
- 70L tank capacity
- Heated system (40 to 46°C)



#### SIGNATURE PARTS WASHER

CODE SW-25

- Original design
- Stationary unit
- Entry level unit
- 100L tank capacity
- Heated system (40 to 46°C)



#### SUPERSINK PARTS WASHER

CODE SW-28

- 2x Double brush stations
- Stationary unit
- XL internal sink
- 100L tank capacity
- Heated system (40 to 46°C)



#### MOBILE HEAVYWEIGHT

CODE SW-37

- Heavy-duty capacity
- Mobile unit
- 2x Double skinned
- 100L tank capacity
- Heated system (40 to 46°C)

#### CONSUMABLES



#### PARTS/BRAKE CLEANING

CODE SW-4

All-round heavy-duty degreaser, suitable for almost any application with exceptional performance.

- Most popular
- Best all-rounder



#### HEAVY DUTY DEGREASER

CODE SW-X1

Formulated to tackle the most extreme cleaning applications with ease.

- Max performance
- Heavy-duty cleaning



#### AIRCRAFT, WEAPONS & SELECTED METALS

CODE SW-8

Designed for soft and ferrous metal. Excels as a weapons cleaner and other specialty cleaning applications.

- Industry certified
- Specialist cleaner



#### OZZYMAT®

CODE FL-4

Offers a safe and reliable way to ensure the CRC SmartWasher® performs to the high demands of your industry.

- Weekly peelable layers
- Traps particles down to 50 microns

#### PRICING

SW-23-4	Starter Kit SmartWasher-23 SW-4 FL-4	\$4,160	FL-4	SmartWasher OzzyMat	\$42
SW-25-4	Starter Kit SmartWasher-25 SW-4 FL-4	\$3,905	SW-4	SmartWasher OzzyJuice SW-4 20L	\$205
SW-28-4	Starter Kit SmartWasher-28 SW-4 FL-4	\$4,750	SW-8	SmartWasher OzzyJuice SW-8 20L	\$205
SW-37-4	Starter Kit SmartWasher-37 SW-4 FL-4	\$5,630	SW-X1	SmartWasher OzzyJuice SW-X1 18.9L	\$265
SW-37-X1	Starter Kit SmartWasher-37 SW-X1 FL-4	\$5,895			

Contact your local store for pricing on other models not listed. All starter kits include enough fluid and mats to commission the machine.

#### PROMOTION

Purchase any **SMARTWASHER & START-UP KIT** and receive a **BONUS gift\***

*Scan to learn more*

\*Purchase any CRC SmartWasher + start-up kit and receive a BONUS gift. Fluids in start-up kit vary depending on machine purchase. Promotion period: 01/01/2024 to 31/03/2024. While stocks last. Terms and conditions apply. Promotion only applies to the following SKUs: SW-23 kit, SW-25 kit, SW-28 Kit, and SW-37 kit. [Hunting & Fishing gift card terms also apply.](#)

CRC [www.crc.co.nz](http://www.crc.co.nz)



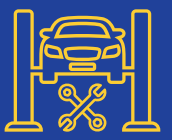

## Workshop Scrubber - Roller

A compact scrubber dryer that is suitable for a variety of applications. It has a collapsible push handle and detachable tanks, which can be easily transported perfect if using at multiple sites.

### Features:

- Powerful and fast cleaning
- Immediate dry floor after washing
- Low ground clearance
- Easy maintenance
- For indoor/outdoor use

BR 40/10 C ADV

# \$4,499

OR \$25 PW\* SEE PAGE 30 FOR FINANCE DETAILS.



**KÄRCHER**

## Wet & Dry Vacuum Cleaner NT27/1

### Features:

- 27L impact resistant container
- Low operating & maintenance costs
- Ideal for vacuuming coarse dirt, dust & liquids

### Specifications:

Suction Power 1,380W  
Flow Rate 67L/min

NT27/1

# \$429



**KÄRCHER**

## Hot Water Blaster - Electric/Diesel Boiler HDS 5/11 U

This robust, high pressure hot water blaster offers outstanding mobility, ideal for trade environments & workshops.

### Features:

- 10m high pressure
- EASY! Force trigger gun technology

### Specifications:

Pressure 1,595psi  
Flow Rate 7.5L/min  
Maximum Temperature 80°C

HDS 5/11U

# \$3,299

OR \$18 PW\* SEE PAGE 30 FOR FINANCE DETAILS.



**KÄRCHER**



## Ultrasonic Cleaner 120W 3L

### Features:

- 120W ultrasonic power/100W heating power
- Supplied with metal basket
- Stainless steel tank
- Digital timer
- Digital temperature setting

### Specifications:

Inner Dimensions 240 x 140 x 100mm (LxWxH)

ET3201A

# \$699



### Also Available

ET3204-200	Cleaning Powder 200g	\$39
ET3204-1KG	Cleaning Powder 1kg	\$79



## Ultrasonic Cleaner 240W 10L

### Features:

- 40kHz frequency
- Drainage tap
- Supplied with metal basket
- Stainless steel tank
- Digital timer
- Digital temperature setting

### Specifications:

Inner Dimensions 330 x 270 x 150mm (LxWxH)

ET3202A

# \$1,199



### Also Available

ET3204-200	Cleaning Powder 200g	\$39
ET3204-1KG	Cleaning Powder 1kg	\$79



## Ultrasonic Cleaner 600W 30L

### Features:

- Dual 33kHz (coarse)/40kHz (intensive) frequency
- 600W ultrasonic power/ 500W heating power
- Drainage tap
- Supplied with metal basket
- Stainless steel tank
- Digital timer (1-99 minutes working time)
- Digital temperature setting (0-80°C range)

### Specifications:

Inner Dimensions 500 x 300 x 200mm (LxWxH)

ET3203A

# \$2,499



### Also Available

ET3204-200	Cleaning Powder 200g	\$39
ET3204-1KG	Cleaning Powder 1kg	\$79



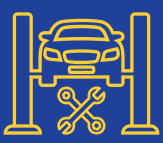

# GENERAL GARAGE

## Brake Check

Compact brake testing instrument offering most of the same features as the Brake-Testa.

- Portable with rechargeable battery
- Uses accelerometer technology
- Can be downloaded to a PC
- Wireless printer available
- Automatic triggering
- GPS equipped model also available to provide test location details

### BRAKECHECK 2

# \$1,385



## 60 Tonne Hydraulic Press

- Electro hydraulic motor pump
- Made in Denmark

### Specifications:

Stroke 300mm  
 Width Between Legs 1,010mm  
 Depth Between Legs 259mm

### P60EH2

# \$12,995

OR \$72 PW\* SEE PAGE 30 FOR FINANCE DETAILS.



## Headlight Beamsetter

Digital lux meter 1,660mm column in blue. Three wheel stable base with adjustable inclination setting top mirror visor adjustment to ensure centre line of front bumper. Stability level with sliding mechanism with self lubricated nylon skates for easy operation of height adjustment.

### 020999167

# \$995

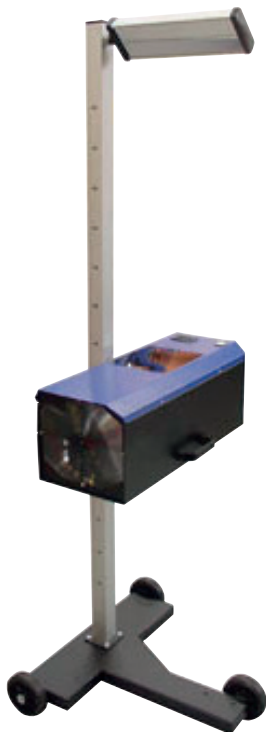

## Laser Labs Inspector II Tint Meter

### Includes:

- Two N.I.S.T. traceable reference samples
- User manual
- Certificate of Accuracy
- Carrying case
- Tint law card

### TM12

# \$399

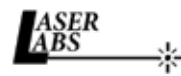

Also Available

TME2 Enforcer II Tint Meter **\$359**

## Lifting Platform

- The aggregate lifting table can be used universally, thus making it excellent for safely removing and installing engines, gearboxes, HV batteries and chassis components from a wide range of manufacturers
- Foot operated
- Fully mobile
- Highly stable lifting Specifications

### Specifications:

Capacity 1,000kg  
 Minimum Height 635mm  
 Maximum Height 1,965mm

### KT100XT

# \$5,900

OR \$34 PW\* SEE PAGE 30 FOR FINANCE DETAILS.



## Digital Headlight Beam Tester

Some modern cars have headlights that use Matrix, DLA and ILS beam technology to improve driver visibility while at the same time reducing glare for oncoming traffic and pedestrians. Improved road safety is achieved by specifically targeting where the light does/doesn't reach.

- Available Reading: halogen, xenon, LED, low beam, high beam, fog beam
- Beam pattern: European left/right hand driving, USA, Japan
- Communication Protocol: Net1, Net2, Giegnet, GiegLan, OTC Lan.  
 Software Update: USB Key, LAN configuration through RS232.  
 Connectivity: RS232, Wifi, Bluetooth®

### 127999041

# \$6,145

OR \$35 PW\* SEE PAGE 30 FOR FINANCE DETAILS.





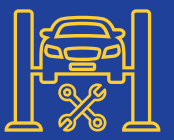

## MaxiSys 8" Diagnostic Scan Tool

The MS906PRO is a complete re-design of the biggest selling Autel model, the MS906BT. Using the latest technology, updated Android OS, and a redesigned user interface the MS906PRO is a "must have" for any Kiwi workshop. Featuring an 8" Screen, and new FD CAN/DolP compatible V200 Bluetooth VCI the MS906PRO is compatible with most vehicles on the market today, and future technologies to come.

- ADAS Calibration (subscription required)
- Enhanced all system AutoSCAN with ADAS identification
- PreSCAN and PostSCAN diagnostic reports
- Bi-directional controls / data logging
- Customer diagnostics reports / print and save easily
- 25 service functions
- Android 7.0 operating system
- Octa-core processor
- 128GB memory/4GB ram
- Includes Bluetooth VCI 200
- 11,600Ah battery
- 8" Touchscreen
- 16MP rear camera / 5MP front camera
- Compatible with BT506 battery testers

**MS906PRO**

**\$4,195**

OR \$25 PW\* SEE PAGE 30 FOR FINANCE DETAILS.



Also Available

**MS906PRO-TS** \$4,795 OR \$28 PW\* SEE PAGE 30

**AUTEL**



## X-431 PRO3 SE Mainline 10" Scantool

The X-431 PRO3 V5.0 is the latest "Mainline" Scantool from Launch. Featuring a custom designed 10" Tablet, and the latest DBSCar VII VCI. Functions of the PRO3 V5.0 can be further enhanced with optional TS GUN PRO, O2-2, BST-360, X-Prog 3, and HD3 add-on modules. Includes 3 Years Software Updates.

**X431PRO3SE**

**\$4,115**

OR \$23 PW\* SEE PAGE 30 FOR FINANCE DETAILS.



**LAUNCH**



## MaxiSys 3rd Gen 10" Diagnostic Scan Tool

- Display - 9.7" Touchscreen (1,536 x 2,048px)
- OS - Android 7.0
- Processor - 2.3GHz + 1.7GHz Octa-Core
- RAM - 4GB
- Upgraded Bluetooth VCI for faster speed and capability
- Network topology mapping for easy navigation
- Relevant cases, troubleshooting with real-fix reference video library
- Cloud based programming for BMW & Mercedes-Benz

**MS909**

**\$7,495**

OR \$43 PW\* SEE PAGE 30 FOR FINANCE DETAILS.



Also Available

**MS909EV** \$9,495 OR \$54 PW\* SEE PAGE 30

**AUTEL**



## X-431 PAD V2.0 Advanced 10" Scantool

The X-431 PAD V 2.0 is a high-end comprehensive Scantool updated in 2022. Featuring Dual 2.4 & 5GHz Wi-fi to allow simultaneous connection to Wi-Fi Internet network and to the J2534 enabled Smartlink C VCI. Enhanced Software including Native Cloud Based Programming for selected BMW, Mercedes Benz and Audi/VW Vehicles. The 10" Gorilla Glass screen provides excellent visibility in bright sunlight conditions. Can be further enhanced with Optional TS GUN PRO, O2-2, BST-360, X-Prog 3, and ADAS.

**X431PADV2.0**

**\$7,295**

OR \$40 PW\* SEE PAGE 30 FOR FINANCE DETAILS.



**LAUNCH**



## MaxiSys 3rd Gen 13" Scan Tool with Oscilloscope

Has all the features of the MS919 including:

- J2534 Pass Thru capability
- 4 channel wireless oscilloscope
- Multi-meter
- Waveform generator
- Can Bus Network checking ability via OBD2 PLUS
- Twice the storage capacity (256GB)
- 12.9" Touchscreen
- Split screen function
- Supplied with MSOAK & MSOBD2KIT accessory kits

**MSULTRA**

**\$10,995**

OR \$62 PW\* SEE PAGE 30 FOR FINANCE DETAILS.

Also Available

**ULTRAEV** \$12,995 OR \$73 PW\* SEE PAGE 30



**AUTEL**



## X-431 PAD VII Premium 13" Scantool

The latest, premium model from Launch, The PAD VII is the highest featured Scantool currently available featuring a 13.2" screen that can be split to multitasking, 2.0GHz Octa-Core Processor, 256GB Memory and 8GB RAM running on a Android 9.0 platform. The Supplied Smartlink C VCI as well as being DoIP & FD CAN capable can also be used as an independent connection with Launch, OE, and even other Aftermarket Scantool brands. Enhanced Software including Native Cloud Based Programming for selected BMW, Mercedes Benz and Audi/VW Vehicles. Can be further enhanced with Optional TS GUN PRO, O2-2, BST-360, X-Prog 3, and ADAS.

**X431PADVII**

**\$9,150**

OR \$50 PW\* SEE PAGE 30 FOR FINANCE DETAILS.



**LAUNCH**



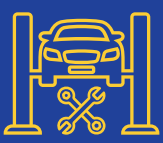

# DIAGNOSTICS

## F7S-G Multi-Fleet Diagnostic Scan Tool

The FCar F7S-G Diagnostic Tablet is an all-in-one diagnostic and service maintenance solution ideal for truck and construction vehicles that also supports many popular brands of passenger vehicles. The platform is based on an Android Operating System and has built in Wi-Fi and Bluetooth so it can be used wherever you are around the vehicle. The tool supports powerful diagnostic functions, reset and special bia-directional functions, plus online updates to ensure fast and relevant diagnostic capability.

- Ruggedized Tablet with 10.1" Display
- All in one Diagnostic solution for Auto and Truck Professionals
- 64GB Internal SSD Storage
- Full Adaptor Packing including Pre-OBDII support for HD & Passenger Vehicles
- Single License renewal across all Diagnostic Software
- 2 Years Free Software Updates

FCARF7S-G

# \$8,195

OR \$45 PW\* SEE PAGE 30 FOR FINANCE DETAILS.



Also Available

FCARF7S-G-TI

FCAR F7S-G Trade In Offer (Offer only available to existing FCar, F3 and F5 Owners)

**\$5,500** OR \$30 PW\* SEE PAGE 30



## Automotive Diagnostic Scan Tool

Features:

- Fast and easy operation with intuitive layout
- Smart online software updates directly on the tablet
- 12 and 24 Volt system coverage
- Quick system search automatically scans all the vehicles systems
- Key programming, adas calibration and injector coding
- Service indicator reset, pre/post scan reporting
- Adaptations, recording and DPF regeneration
- J2534 compatible and diagnostics
- Made in Korea
- 2 Years Free software updates

Specifications:

- Powerful Octa-core processor with Android 9 OS
- 8" Full HD LCD display
- Touch screen with 3 hard keys (Power, Volume + & -)
- 8 Megapixel auto-focus camera with led flash
- Loudspeaker, microphone, and standard audio jack
- Rechargeable 3,200mAh Li-Ion battery
- Operating voltage 9-30V
- Ambient light, proximity, gyroscope, and accelerometer sensors
- 3x USB ports (1x USB 2.0 and 2x USB 3.0)
- RJ45 Ethernet, Wi-Fi 802.11 A/B/G/N and Bluetooth 4.2

Z5-S0 - Z5 with OBD-II Adaptor Only - **\$8,250** OR \$47 PW\*

Z5-CTK - Z5 with Premium Adaptor Kit - **\$9,650** OR \$55 PW\*

# FROM \$8,250

OR \$47 PW\* SEE PAGE 30 FOR FINANCE DETAILS.



**TRADE-IN OPTION AVAILABLE FOR G-SCAN OWNERS**

Also Available

Z5-TRBK

Trade In Kit on G1,G2, G3 - Conditions Apply

**\$6,750** OR \$51 PW\* SEE PAGE 30



## PicoBNC+™ 4 Channel Standard Oscilloscope Kit

Standard Diagnostic Kit includes the 4425A Picoscope module, PicoBNC+™ test probes, and accessories in a sturdy carrying case

PQ178

# \$5,458

OR \$30 PW\* SEE PAGE 30 FOR FINANCE DETAILS.



## PicoBNC+™ 4 Channel EV Enhanced Oscilloscope Kit

Electric Vehicle (EV) kit includes special accessories and a new set of Guided Tests to provide comprehensive diagnostics capability for all types of EV (BEV, MHEV, PHEV, Fuel-cell), and ICE (Diesel, Gasoline, LPG) systems, including insulation and safety testing

PQ196

# \$9,103

OR \$50 PW\* SEE PAGE 30 FOR FINANCE DETAILS.



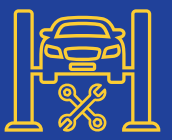

## SmartSafe P01 EV/Hybrid Vehicle Scantool

The P01 Scantool is the world's first dedicated EV/Hybrid Vehicle Scantool.

Connection to the vehicle is via three different methods:

- Dedicated Adaptor Connection to the Battery Pack
- Universal Jumper Connection to the Battery Pack
- OBD Connection to the Vehicle

Using the P01 Scantool technicians can view battery pack BMS data and Cell information including cell/module voltage, input/output current and power, battery temperature and more in real time.

**EVPO1**

# \$8,795

OR \$48 PW\* SEE PAGE 30 FOR FINANCE DETAILS.



**LAUNCH**

## SmartSafe P03 EV/Hybrid Advanced Scantool

The P03 Scantool is the Advanced EV/Hybrid Vehicle Scantool from SmartSafe, including all the features and benefits of the P01 model and adds the following:

- Oscilloscope Module
- Insulation Detection/Testing Module
- Multimeter
- Amp Testing/Current Clamp (Optional Extra)

**EVP03**

# \$10,695

OR \$59 PW\* SEE PAGE 30 FOR FINANCE DETAILS.



**LAUNCH**

## SmartSafe ET30 EV Battery Pack Airtightness Detector

The ET30 is high-precision non-destructive testing system. Using compressed air as a medium to exert controlled pressure on the inner cavity or outer surface of EV battery pack or EV Cooling System to be tested. Then using high-sensitivity sensors to detect the change of pressure, as to determine the sealing performance of the system being tested. This is required testing to ensure the safety of the EV Battery Pack for either General Servicing of the Vehicle or when the Battery Pack has been opened for repair.

**EVET30**

# \$10,995

OR \$61 PW\* SEE PAGE 30 FOR FINANCE DETAILS.



**LAUNCH**

## SmartSafe EB240 Battery Pack Cell Equalizer

The EB240 EV Battery Pack Cell Balancer adopts the latest balance maintenance test technology which does not interfere with the BMS Management System. Its main use is for Lithium battery charge, discharge testing and cell balance maintenance.

**EVEB240**

# \$21,950

OR \$121 PW\* SEE PAGE 30 FOR FINANCE DETAILS.



**LAUNCH**

## SmartSafe EP260 Integrated Battery Pack Charging and Discharging Unit

Employing state of the art charging and discharging techniques, and according to the charging and discharging characteristics of lead-acid batteries/lithium-ion batteries, the EP260 can carry out a variety of test and maintenance modes. This is suitable for the discharging, charging, cyclic charging and discharging tests of various lead-acid batteries and lithium-ion batteries.

**EVEP260**

# \$23,950

OR \$132 PW\* SEE PAGE 30 FOR FINANCE DETAILS.



**LAUNCH**

## SmartSafe 12/24V DC Adjustable Digital Power Supply

An intelligent power supply for EV and ICE vehicles, designed with isolated low and high voltage modules to provide dual output. The DP750 can be remote controlled by bluetooth to adjust multiple working requirements.

**EVDP750**

# \$4,950

OR \$27 PW\* SEE PAGE 30 FOR FINANCE DETAILS.



**LAUNCH**

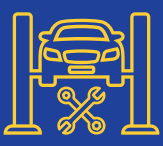

# EV CHARGERS

## MaxiCharger AC Wallbox Electric Vehicle Charger with Tethered Type 2 Charging Cable

### Features:

- Single phase up to 7.4kW/32A (MAXIEUACW7-C5-DG)
- Three phase up to 22kW/32A (MAXIEUACW22-C5-4G-DG)
- Up to 7 times faster than tradition AC chargers
- Tethered Type 2 charging cable (5m)
- Dynamic load balancing
- Wi-Fi, Bluetooth and ethernet connectivity
- IK10 high impact resistance
- IP65 rating (indoor or outdoor installation)
- LED status indicators
- RFID card
- Autel charge cloud portal and OCPP capability
- Autel charge application (IOS and Android)
  - Start, stop and schedule charging remotely
  - Track your EV battery health while charging
  - Charge history
- 3 Year Warranty
- CE Certification
- Colour: Dark grey
- Wall mount with bracket
- Optional: Pedestal mount

MW7KW1PH-C - Single Phase - **\$1,599**

MW22KW3PH-C - Three Phase - **\$1,950**

MW22KW3PH-C-T - Three Phase Touch Screen - **\$2,300**

**FROM \$1,599**

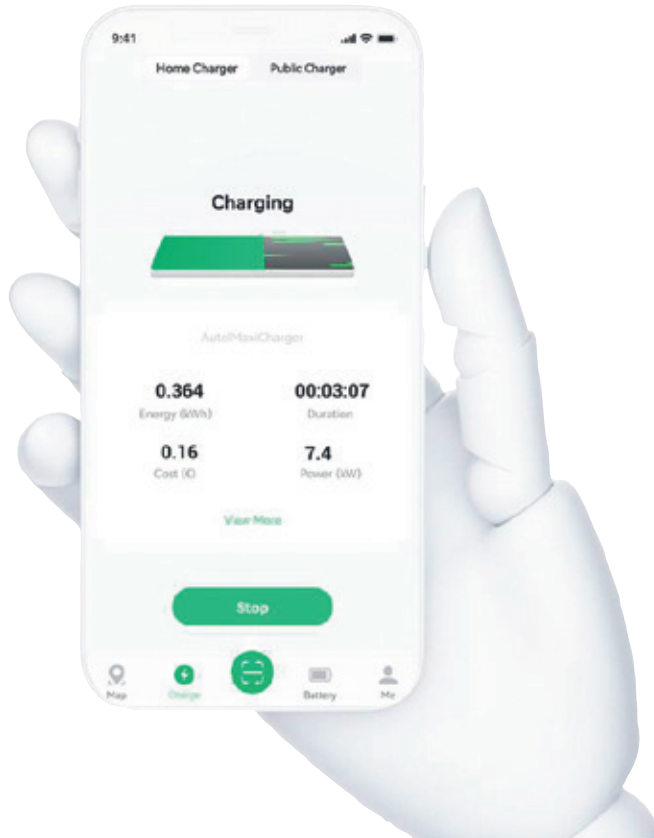

## AUTEL

### AC Wall Box Pedestals

PED-SINGLE - Single - **\$550**

PED-DUAL - Dual - **\$580**

**FROM \$550**



## AUTEL

DUAL WALL BOX SHOWN

### AC Wall Box Fascia Plates

MP-SILVER - Silver

MP-WHITE - White

MP-ROSEGOLD - Rose Gold

**\$55 EACH**



## AUTEL

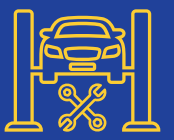

## EV Upgrade Kit

The EV Diagnostics Upgrade Kit includes EVDiag Box and adapters for specific electric vehicles to perform battery pack analysis. The EVDiag Box is compatible with the MaxiSys Ultra, MaxiSys Ultra ADAS, MaxiSys MS919, and MaxiSys MS909 tablets. EVDiag Box connects to MaxiFlash VCI or VCI.

### Features & Benefits:

- Includes EVDiag Box, Adapters for BMW, Tesla, VW and Breakout Leads
- Includes Carrying Case
- State of Charge and State of Health analysis for true battery condition
- Only Suitable with MS909, MS919 & MaxiSYS ULTRA Models

### EVDIAGKIT

# \$1,995



## EV PPE Safety Kit

For technicians who already have a full tool kit but just need the PPE and safety gear to make the work area safe.

### EVC-SAFETY-KIT

# \$1,780



## Insulated Socket Sets

Part No.	Description	Price
IS218	1/4" Dr. Metric 18pc	\$299
IS319	3/8" Dr. Metric VDE 19pc	\$459
IS424	1/2" Dr. Metric VDE 24pc	\$599



## VDE Pliers Set 3pc 1000V

4932464575

# \$169



## VDE Insulated Screwdriver Set 7pc 1000V

A78017

# \$69



## VDE Insulated Ring End Set 5pc Metric 1000V

IS6101

# \$125



## Digital Insulation Tester, Hybrid & Electric

Specially designed for testing insulation on high voltage cables. An essential tool for working on hybrid or electric vehicle systems. Circuitry inside the unit is built specifically to safely cope with high voltages and currents found in these types of vehicle.

- Conforms to EN61010 / CAT III (1000V)
- Supplied with test leads, batteries and carry case

ET2134

# \$499



## Wrench Sets

VDE insulated 1000V

Part No.	Description	Price
HK06B	Long Hex Key 6pc	\$60
AP2502	TORX Long Key 9pc	\$83



# MAKING THE EVERYDAY EASY AS.

**MORE EASY  
SEARCH  
OPTIONS  
AVAILABLE**

At NAPA Auto Parts we know time is money. That's why we have added more search options to speed up finding the right part to get your customer back on the road quickly.

## Find parts faster

More ways to search for the right part by make, model, and year or by rego. PLUS looking for hard to find parts? Now you can cross reference part attributes with make, model, and year.

## Order anytime, anywhere

Order anytime with live inventory meaning you secure the parts you need when ordering via PROLink. What to reorder a part? Use the bar code scanner on the PROLink mobile app to speed up your workshop.

## Reduce your admin time

See your price and the RRP quickly to cost a job, view current and old invoices in one place, and review your price to schedule jobs accordingly.

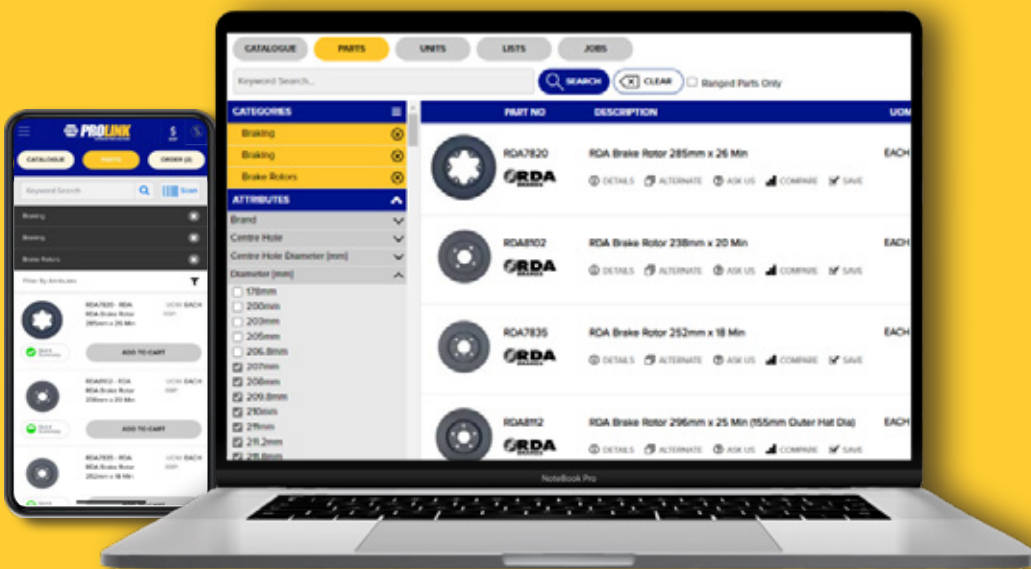

## Barcode scanner

Order a new part or stock item by scanning the barcode using the mobile App. Go to the PARTS tab and hit the scan icon. A great time saving feature for high volume or regularly ordered products.

Look for the barcodes in this catalogue

**Scan here to  
see how easy  
it is to use:**



Getting started is as easy as calling your rep today on 0800 800 073



# NEED FINANCE?

Talk to your Rep or Branch Manager today.



STRONGER WITH  
**CAPRICORN™**  
PREFERRED SUPPLIER

**CrediFlex**



Lease options available

Finance offer is per unit of equipment and available to approved purchases on equipment of \$3,000 and over by Capricorn and \$5,000 and over by CrediFlex.

Whilst all care will be taken in the preparation of published payment figures, the figures cannot be confirmed until a formal approval is in place. Repayment options available from 12 to 60 months.

For full details and Terms & Conditions talk to your Branch Manager or Rep.

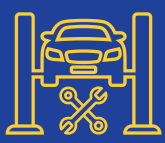

# TOOL STORAGE

## Tool Chests & Roller Cabinets

Montezuma brand goes back 30 years, it has never wavered in its commitment to innovation and its passion for helping the working person be the best they can be.

Part No.	Description	Price
Tool Chests		
<b>BKM362404CH</b>	36" 4 Drawer - 930 x 625 x 625mm (WxDxH)	<b>\$1,150</b>
<b>BKM462406CH</b>	46" 6 Drawer - 1,117 x 625 x 635mm (WxDxH)	<b>\$1,350</b>
<b>BKM722410CH</b>	72" 10 Drawer - 1,846 x 625 x 635mm (WxDxH)	<b>\$2,699</b>



BKM362404CH

BKM462406CH

BKM722410CH

Part No.	Description	Price
Roller Cabinets		
<b>BKM362406TC</b>	36" 6 Drawer - 930 x 630 x 625mm (WxDxH)	<b>\$1,599</b>
<b>BKM462411TC</b>	46" 11 Drawer - 1,170 x 625 x 1,045mm (WxDxH)	<b>\$1,999</b>
<b>BKM722416TC</b>	72" 16 Drawer - 1,846 x 625 x 250mm (WxDxH)	<b>\$3,799</b>



BKM362406TC

BKM462411TC

BKM722416TC



### 26" Roller Cabinet Black

- Features:**
- Heavy-duty top rubber mat
  - Robust 125mm energy absorbing rubber racing casters, 2 with brakes
  - High security tubular locks

**TR2608BK** - 8 Drawer - **\$1,099**  
**TR2606BK** - 6 Drawer - **\$999**



### 26" 6 Drawer Top Chest

- Features:**
- Compact size
  - Anti slip drawer liners

**Specifications:**  
 Dimensions 660 x 312 x 381mm (LxWxH)  
 Weight 27kg

**TC2606BK** - Black  
**TC2606RD** - Red

**\$599**  
**EACH**



### 32" Heavy Duty Wall Cabinet

Hang your tools up in this heavy duty wall cabinet, throw your bits and pieces in the slide and glide drawers, and when you've finished, lock them up securely without fear of theft.

**Specifications:**  
 Dimensions 840 x 250 x 900mm (LxWxH)  
 Weight 40kg

**WC32BK** - Black  
**WC32RD** - Red

**\$699**  
**EACH**



### 34" Heavy Duty Road Box Tool Chest

Designed for service vehicles, to securely hold the tools required to get the job done. Each drawer can hold a staggering 80kg of tools and the weather strips ensure tools are kept dry and protected.

**Specifications:**  
 Dimensions 855 x 552 x 700mm (LxWxH)  
 Weight 80kg

**RB3406BK** - Black  
**RB3406RD** - Red

**\$1,299**  
**EACH**



### 52" 12 Drawer & Tool Hutch Combo

- Features:**
- 12x drawers (2x full width drawers, 1x extra deep)

**Specifications:**  
 Dimensions 1,321 x 562 x 1,788mm (LxWxH)  
 Weight 257kg

**GF5212BK** - Black  
**GF5212BU** - Blue  
**GF5212RD** - Red

**\$4,299**  
**EACH**



### 76" 22 Drawer Roller Cabinet

- Features:**
- Stainless steel work top

**Specifications:**  
 Dimensions 1,932 x 770 x 1,107mm (LxWxH)  
 Weight 500kg

**GF7622BK** - Black  
**GF7622BU** - Blue

**\$6,699**  
**EACH**



### 27" 7 Drawer Roller Cabinet

- Features:**
- 5 standard drawers, 1 double drawer & 1 extra deep drawer
  - Anti slip drawer liner

**Specifications:**  
 Dimensions 712 x 611 x 1,064mm (WxDxH)  
 Weight 120kg

**GF2707BK** - Black  
**GF2707BU** - Blue  
**GF2707GR** - Green  
**GF2707RD** - Red

**\$1,359** EACH



### 47" Godfather 8 Drawer Top Chest

- Features:**
- 6 Standard drawers & 2 full width drawers
  - 2 Electrical access points

**Specifications:**  
 Dimensions 1,204 x 611 x 624mm (LxWxH)  
 Weight 130kg

**GF4708BK** - Black  
**GF4708RD** - Red  
**GF4708OR** - Orange  
**GF4708BU** - Blue

**\$1,499** EACH





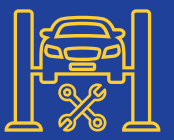

## Air Hose Reels

- Features:**
- Auto lock and slow retracting hose reel with guide system for neat retraction
  - 2 Years anti-UV protection
  - CE & ROHS certificate (Patented)

Part No.	Description	Price
Q20	20m	\$206
Q30	30m	\$244



**AUTO STAR**

## ARO 1/4" BSP Coupler Set 5pc (Carded) SA4421

**\$27**



**SUMAKE**

## 1/2" Air Reversible Drill STM5012

**\$199**



**SUMAKE**

## Air Hydraulic Riveter Kit

**Specifications:**

Blind Rivet Capacity	3/32"/2.4mm, 1/8"/3.2mm, 5/32"/4.0mm & 3/16"/4.8mm
Traction Power	720kg
Jaws	2

**6615**

**\$189**



**SUMAKE**

## 3/8" Reversible Air Angle Drill

**Specifications:**

Maximum speed	1,800 rpm
Air consumption	400 L/min (14 CFM)

**ST4436**

**\$215**



**SUMAKE**

## 8" Central Vacuum Gear-Driven Sander with 8" Hook Pad

**Features:**

- Low vibration
- Light weight
- Innovative anti-dust protection system

**Specifications:**

Orbit Diameter	5mm (standard)
Free Speed	900 rpm
Air consumption	427 L/min (15 CFM)

**ST7110DC8**

**\$499**



**SUMAKE**

## Air Belt Sander 10 x 330mm

An ideal tool for deburring, cleaning, and finishing in tight or hard-to-reach areas in automotive after-service, and any composite, wood or metal manufacturing industries.

**Specifications:**

Belt Size	10 x 330mm
Free Speed	17,000rpm
Air Consumption	480 L/min (17 CFM)

**BS110B**

**\$210**



**SUMAKE**

Also Available

**BS110G** Air Belt Sander 20 x 520mm **\$340**

## 1/4" 0.5HP Straight Air Die Grinder

Durable 0.5HP air motor with precision machined cylinder & rotors.

**Specifications:**

Free Speed	22,000rpm
Net Weight	0.7kg
Air Consumption	368 L/min (13 CFM)

**419DG1002L**

**\$99**



**SUMAKE**

## 1/4" Air Angle Die Grinder

Durable 0.5HP air motor with precision machined cylinder & rotors.

**Specifications:**

Free Speed	18,000rpm
Net Weight	0.8kg
Air Consumption	368 L/min (13 CFM)

**STDG1012LDA**

**\$140**



**SUMAKE**

## 5" Air Angle Grinder with 100° Angle

**Specifications:**

Free Speed	10,000rpm
Air consumption	540 L/min (19 CFM)

**STP7737A**

**\$220**



**SUMAKE**

## 1/2" Jumbo Hammer Air Impact Wrench

**Specifications:**

Free Speed	9,500rpm
Air consumption	480 L/min (17 CFM)

**STC5148**

**\$340**



**SUMAKE**

## 1/2" Composite Twin Hammer Air Impact Wrench

Advanced technical composite housing and ergonomic design. Excellent twin hammer impact system.

**Specifications:**

Maximum Torque	1,000ft/lbs (1,355Nm)
Free Speed	8,500rpm
Air Consumption	480 L/min (17 CFM)

**STC554S**

**\$340**



**SUMAKE**

## 3/4" Impact Wrench Twin Hammer Professional

**Specifications:**

Free Speed	6,000rpm
Torque	1,200/1,500ft/lbs (working/max)
Weight	3.0kg

**STC5644**

**\$960**



**SUMAKE**

## 1" Air Impact Wrench Twin Hammer

**Specifications:**

Free Speed	5,500rpm
Torque	1,500ft/lbs (2,034Nm)
Weight	3.7kg

**STC594**

**\$999**



**SUMAKE**

## 1" Composite Air Impact Wrench Twin Hammer

**Specifications:**

Free Speed	5,500rpm
Torque	2,200ft/lbs (2,983Nm)
Weight	6.2kg

**STC594**

**\$1,499**



**SUMAKE**

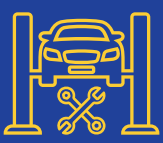

# BRAKE SERVICE

## Brake Cylinder Hone

Part No.	Description	Price
2310	3 Leg, 19-64mm	\$38
2315	2 Leg, 15-64mm	\$35



## Brake Hose Disconnect Set 6pc

Simply push release tool into connector and pull the hose by hand to separate. For use on most truck and bus brake hose connectors.

Sizes:  
• 6, 8, 10, 12, 15 & 16mm  
2040

\$23



## Brake Caliper Press Spreader

• Works on twin and quad piston calipers  
• Works on single and twin piston floating calipers  
2059

\$83



## Digital Vernier for Disc Brake Calipers 150mm

To check wear, thickness and score depth on disc brake rotors. External / depth measurement, mm / inch interchange button, zero setting at any position.

MT991

\$197



## Colour Coded Manual Brake Gauge Set 8pc

This brake gauge gives an accurate measurement of the amount of brake lining left without guess work.

Specifications:  
Red 2 & 3mm  
Yellow 4, 5 & 6mm  
Green 8, 10 & 12mm

2101

\$50



## Brake Hose Crimp Pliers

Positively seals reinforced brake hoses. Round jaws prevent hose damage, adjustable sliding locking ring allows pinch-off pressure to be maintained.

Specifications:  
Capacity 16mm  
Dimensions 200mm (L)

2030

\$22

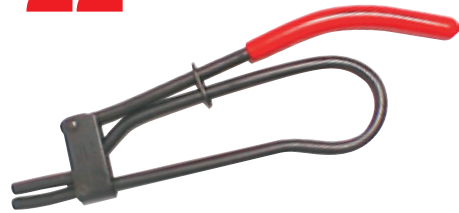

## Disc Brake Piston Cube

Rotates pistons back into brake calipers when replacing pads. Unique "cube" design provides five drive pin configurations to fit many applications.

Specifications:  
Compatible 3/8" Drive tools  
2020

\$25



## Brake Spring Pliers

General purpose brake spring pliers for the removal and replacement of Bendix, Lockheed, Girling and other types of brake springs.

Specifications:  
Capacity 125mm  
Dimensions 355mm (L)  
2426

\$38



## Brake Bleeder Recharging Tank

Clamp this recharging tank to the master cylinder reservoir, open the tap valve and you can keep the fluid to the correct level whilst bleeding each brake nipple.

Specifications:  
Capacity 1,000mL  
QS2102

\$95



## Brake Fluid Tester (DOT3 & DOT4)

Use to check the quality of brake fluid. 5 LED's indicate the quality and percentage of water in the brake fluid. Suitable for DOT3 and DOT4.

6512B

\$42



## Brake Resetting Gauge

Use gauge to set the proper clearance between linings and drum prior to assembly. Inside calipers measure drum diameters and outside calipers transfer measurement to brake shoes. Knurled knob locks tool at the required measurement.

Specifications:  
Range 165-337mm (6.1/2-13.1/4")  
2380

\$57



## Pressure Brake Bleeder with Adaptors WH505C

\$614



## Brake & Accelerator Pedal Jack

Trigger controlled unit slides handle to any position on 28.1/2" (720mm) shaft. Thumb lock releases pressure easily. Use as pedal depressor for brake bleeding.

Specifications:  
Length 762mm (30")  
2222

\$75



## European Truck Disc Brake Caliper Drive Socket

Use to remove and install the disc brake calipers on new European trucks, Volvo etc.

Specifications:  
Size 11 Points 3/8" Drive 26mm Long  
A1390

\$22



## Brake Shoe Retaining Spring Tool

Removes and replaces dish type washers. The tapered knurled cup securely grips the retaining washer on both small & large sizes.

Specifications:  
Length 130mm (5.1/4")  
2044

\$32



## Drum Brake Adjusting Tools

Part No.	Description	Price
2100	13 x 180mm	\$15
2032	Key Style 8 x 16mm	\$16
2033	8 X 130mm	\$20
2034	14 x 190mm	\$24
2028	6 x 125mm	\$25
2031	Japanese Style 8 x 155mm	\$25





## Universal Magnetic Plug Sockets

Part No.	Description	Price
13920	3/8" 5/8" 6pt	\$30
13926	3/8" 13/16"	\$32



## Spark Plug Boot Pliers

This long reach spark plug boot plier is designed to remove hard to reach spark plug boots.

**Specifications:**  
Length 240mm  
3336

**\$35**



## 3/8" Dr. Torque Limited Spark Plug Socket Set

Deep 3/8" Drive Spark Plug Sockets that incorporate a preset clutch that limits the torque for correct tightening of each spark plug.

JS23

**\$219**



## Adjustable Ignition Spark Tester with Lead

Works on all ignition systems. Tests for no start and for spark strength. Gauge background makes spark easy to see even in bright sunlight conditions. Simply plug into spark plug or coil lead and ground to engine.

**Specifications:**  
Length 117mm (4.5/8")  
3405

**\$25**



## Spring Compressor OHV Deluxe

With fine spring loaded jaws that allow access to tight clearance areas.

**Specifications:**  
Length 120mm (4.3/4")  
4057

**\$77**



## Spark Plug Thread Insert Kit 14mm

Unique new method of repairing stripped or damaged threads in aluminium cylinder heads. Solid steel inserts replace damaged threads and eliminate the possibility of coil wind out.

**Includes:**  
• 14mm x 3/8" Long Insert  
• 14mm x 7/16" Long Insert  
• 14mm x 1/2" Long Insert  
• 14mm x 3/4" Long Insert  
• Combination tap & reamer  
4100

**\$36**



## Universal Valve Lifter

Heavy duty construction, universal application.

**Specifications:**  
Maximum Opening 230mm (9")  
4117

**\$188**



## Piston Ring Compressors

Part No.	Description	Price
4214	2-5" x 100mm	\$38
4215	3.5-7" x 165mm	\$63



## Engine Cylinder Hones

Part No.	Description	Price
4325	3 Leg, 50-180mm	\$90
4330	3 Leg, 50-280mm	\$106



## Feeler Gauges

Part No.	Description	Price
7007	Metric	\$32
7016	90° Offset	\$56



## Universal Crankshaft & Camshaft Seal Remover & Installer Kit

Ideal for both crankshaft and camshaft seal. Quick and easy work for both removal and installation.

7535

**\$336**



## Jet Drill Kit

All the sizes you need to ream carburettor jets or any other job with small orifices. Casing handle is knurled for secure holding and has handy pocket clip.

8831

**\$52**

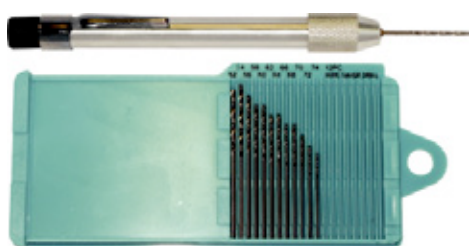

## Alternator Insert Bit Service Set 22pc TX2202

**\$164**



## Injector & Sensor Switch Socket Set

T&E Tools Injector and Sensor Switch Socket Set contains seven different sensor and switch sockets.

J4298

**\$129**



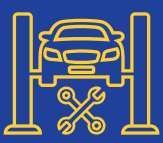

# TEST TOOLS

## Carburetor Leak Detection Tester

Test pop off pressure on carburettor seats by depressing the plunger you can pump to any pressure required up to 30psi (200 kpa).

4431

**\$140**



## Professional Compression Tester 5pc

T&E Tools Professional Compression Tester features quick release chuck for attaching fittings.

4435

**\$106**



## Gasoline Engine Injection Pressure Tester Set

Tests gasoline fuel injection pressure. Set includes pressure gauge, hoses, hook (for hooking gauge under the vehicles hood), a package of extension rubber tubes and clamps with 34 types of fuel valves with various sizes.

4445

**\$1,290**



## Universal Petrol & Diesel Engine Compression & Leakage Test Set

This versatile compression and cylinder leakage kit can do both petrol & diesel engines and covers a wide range of modern engines, including Hdi, TDCi and Pumpe Duse.

4464

**\$793**



## Twin Gauge Cylinder Leakdown Tester

Allows you to accurately diagnose engine problems such as bad valves, worn rings, cracked cylinder walls and blown gaskets.

4496

**\$279**



## Combustion Gas Leakage Test Set

Diagnose cylinder head and gasket leaks by detecting the presence of combustion gases in the cooling system. Universal cone adaptor suitable for most vehicles. Includes 250mL detector fluid. Supplied in storage case. User guide included.

4510

**\$230**



## Coolant Vacuum Purge & Refill Tester

After draining the radiator the tester will evacuate all the air from the system enabling the radiator to be refilled without creating air locks and prevents from the engine overheating.

12275N

**\$180**

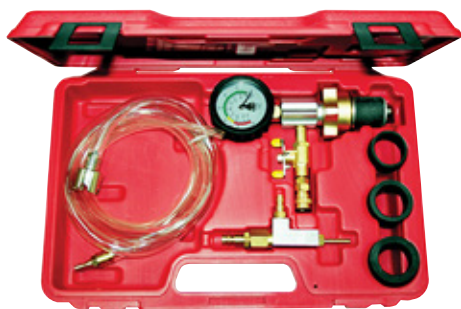

## Master Radiator Pressure & Vacuum Purge & Refill Kit

Comprehensive master kit enables cooling system pressure testing, radiator cap pressure testing and cooling system purge and refill.

GT1019D

**\$655**



## 12-24V DC Power-Up Auto Circuit Tester

A self-powered 12-24VDC continuity tester designed to check a variety of circuits and wiring with the power disconnected. Fitted with a color screen that can be illuminated to make it easy to read.

3011

**\$299**



## Professional Vacuum & Fuel Pressure Tester

Enlarged graduations for accurate readings. Checks for leaky valves, timing, fuel pump vacuum and pressure, fuel line leakage etc.

4428

**\$140**



## Dual Vacuum & Pressure Pump Tester

Superior quality all metal construction vacuum and pressure pump creates and holds a metered vacuum and or pressure for testing and servicing a wide variety of automotive, marine, aircraft and agricultural equipment.

7059

**\$246**



## ABS & Conventional Brake Pressure Tester Kit

Test for leaks or restrictions in the hydraulic portion of both anti-lock and conventional brake systems. Test the hydraulic pressure available to each wheel assembly.

7488

**\$549**

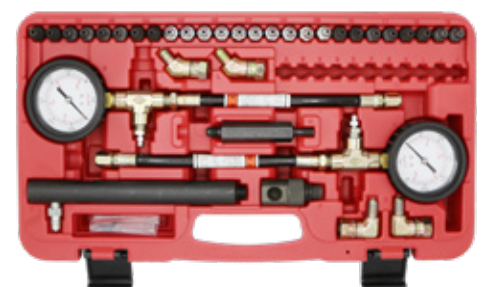

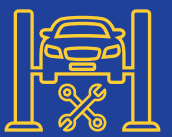

## Truck & Tractor Brake Rivetter

Secure riveting jig in vice. Select correct size punch and anvil to suit the brake rivet. You are now able to hold the brake shoe and lining in one hand and fasten the rivet using a hammer in the other hand. Can also be used on older cars with rivetted brake linings.

2600

**\$172**



## Universal Pitman Arm Puller

The specially shaped drop forged jaws adjust to fit the job correctly. Clamp bolts lock jaws in position to assure positive grip and prevent any slip. Puller will perform many other pulling jobs.

7311

**\$148**



## Truck 5 Leg Rear Hub Puller

This rugged heavy-duty puller will remove wheel hubs mounted on tapered axles and press fit rear brake drums.

9530

**\$467**



## Truck Transmission Bearing Puller

Six sets of split sleeves lock into the circlip groove on transmission bearings and puller tube.

A1120

**\$1,955**



## Ball Joint Removers

Part No.	Description	Price
A1165	Light	\$311
A1112	Medium	\$401
A1102	Heavy Duty	\$435



## Universal Truck Ball Joint Extractor

The universal Truck Ball-Joint Extractor is supplied with three interchangeable forcing forks giving the tool a great range and universal application. The extractor works on eccentric rods and tie rods on nearly all makes of truck and commercial vehicles.

J7265

**\$842**



## Truck Brake Clevis Pin Press

The "C" frame press easily removes rusted and corroded air brake push rod clevis pins when servicing truck and trailer brakes. The pin is easily popped out of the most rusted push rod assembly.

J5057

**\$73**



## Brake Anchor Pin & Bushing Service Set

This rugged forged 'C' frame press easily removes the often rusted truck brake anchor pins. Mechanical screw power does the job quickly with little effort. With this press you can handle truck brake pins up to 1.1/4" (32mm) diameter.

J7248

**\$197**

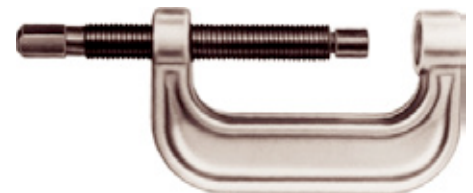

## 1" Drive Budd Wheel Socket Set 5pc

Sizes:

• 1.1/2", 33, 35, 38 & 41mm

J9905

**\$254**



## 1" 2 Speed Dr. Labour Saving Gear Wrench 3,000Nm

This mechanical two speed wrench multiplies the torque output at a ratio of 3 to 1 on the first speed and 58 to 1 on the second speed giving the power to undo and tighten the most stubborn fasteners found on trucks and tractors. It is supplied with two 1" Drive impact sockets in a molded carrying case.

QL88BS

**\$295**



## Truck & Tractor Oil Drain Tray 24L

Extra large polypropylene oil tray for easy drainage of engine and transmission oils on trucks and tractors.

WH083

**\$106**



## Truck Radiator Pressure Test Kit

The kit comes with four tapered adaptors that can quickly expand to make the correct seal on truck radiator necks. The range provides coverage for most Japanese, American and European trucks, tractors, farm equipment etc.

RT919F

**\$327**



## Truck Lug Nut Cap Pliers

Chrome-Plated lug nut caps found on many heavy duty trucks and trailers can be tough to remove, and they are easily damaged if you pry them off or use an ordinary cap remover. This tool avoids those problems.

J5047

**\$29**



## Heavy Duty Oil Filter Wrench

The 1.1/2" (38mm) wide, and 3" (75mm) extra deep tough steel band with unique clamping design will remove the toughest filters without crushing. All sizes 1/2" Square Drive.

4280

**\$75**



## Strap Type Truck Filter Wrench

The heavy duty webbing strap can handle any filter up to 12" (300mm) diameter. The support pad helps to grip the filter without crushing it. The more leverage applied the tighter it grips. Use with any 1/2" drive bar.

4286

**\$69**



## Truck Brake Spring Pliers

Part No.	Description	Price
J7069	Heavy Duty	\$152
J7079	Extra Heavy Duty	\$164



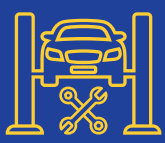

# KNIPEX® HAND TOOLS

## Auto Adjusting Wire Stripping Pliers 180mm

These automatic wire strippers cut and strip cables 0.2-6mm without damaging the wire.

1262180

### \$121

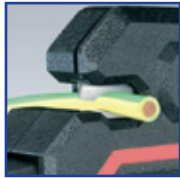

## Circlip Pliers

Part No.	Description	Price
4411J3	Internal Straight - 40-100mm (225mm)	\$53
4411J4	Internal Straight - 85-200mm (320mm)	\$85
4421J31	Internal Bent - 40-100mm (215mm)	\$55
4421J41	Internal Bent - 85-200mm (300mm)	\$90
4611A3	External Straight - 40-100mm (210mm)	\$56
4611A4	External Straight - 85-140mm (320mm)	\$98
4621A31	External Bent - 40-100mm (200mm)	\$62
4621A41	External Bent - 85-140mm (300mm)	\$106

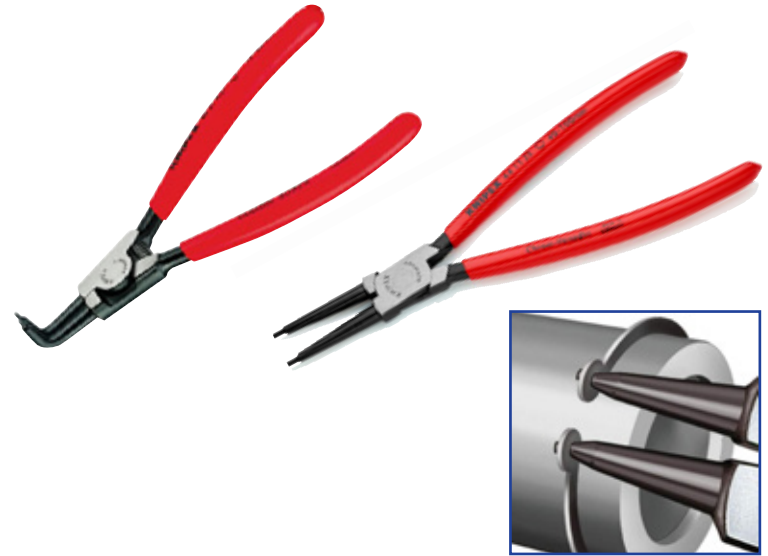

## CoBolt® Robust Compact Bolt Cutters

Part No.	Description	Price
7101200R	200mm	\$113
7101250	250mm	\$132



## CoBolt® XL Compact Bolt Cutter 250mm

For powerful cutting of larger cross-sections as well as very hard materials.

7131250

### \$151



## Cobra® ES Water Pump Pliers 250mm

Features:

- Long, narrow jaws
- Ideal for service, maintenance and equipment repair, in automotive and general industry

8751250

### \$90



## Crimping Pliers for Cable Ferrules

For crimping wire ferrules according to DIN 46228 parts 1 + 4 from 0.25-16mm². The light and slim design makes handling very comfortable with easy crimping due to optimised transmission ratio.

9771180

### \$103



## Ear Clamp Pliers 200mm

Part No.	Description	Price
1098I220	Ear Clamp Plier	\$71
1099I220	Ear Clamp Plier with side cutter	\$90



## Hose Clamp Pliers

Part No.	Description	Price
8551250A	Spring Hose Clamp Pliers 250mm	\$166
8551250C	Hose Clamp for Click Clamps 250mm	\$163



## Trade Pliers Set 4pc

This #1 selling set is a must for every tradesman and includes the most popular pliers used across all industries.

Includes:

- High Leverage Combination Pliers 200mm
- High Leverage Diagonal Pliers 200mm
- Long Nose Pliers 200mm
- Cobra® Water Pump Pliers 250mm
- Tool Roll

002008

### \$234



## Straight & Bent Circlip Pliers Set 8pc

Our top selling circlip pliers set with the eight most popular models for internal and external circlips.

Includes:

- 12-25mm Internal Straight Circlip Pliers 140mm
- 19-60mm Internal Straight Circlip Pliers 180mm
- 12-25mm Internal Bent Circlip Pliers 130mm
- 19-60mm Internal Bent Circlip Pliers 170mm
- 10-25mm External Straight Circlip Pliers 140mm
- 19-60mm External Straight Circlip Pliers 180mm
- 10-25mm External Bent Circlip Pliers 125mm
- 19-60mm External Bent Circlip Pliers 170mm
- Tool Roll

001958V01

### \$416

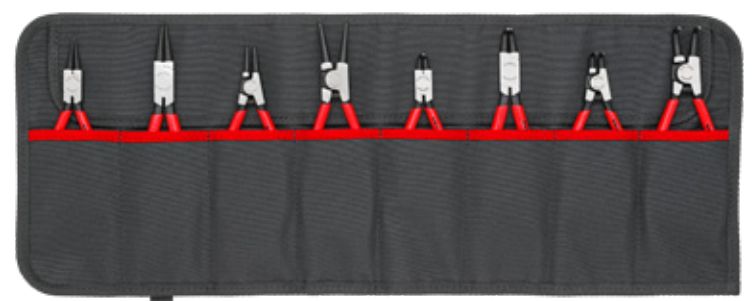

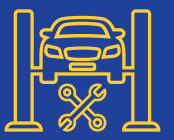

## Tool Check Plus 39pc

Combination tool consisting of a ratchet, bits, sockets, and holder in a minimum of space. Ideal as a universal companion for a whole host of screwdriving applications.

05056490001

**\$159**



## 6 Zyklop Speed Ratchet Sets Metric

Part No.	Description	Price
05004016001	8100 SA 1/4" Drive 28pc	\$229
05004046001	8100 SB 3/8" Drive 29pc	\$289



## 335/350/355/3 Kraffform Plus Extra-Long Screwdriver Set 3pc

Includes:

- 1x Phillips: PH2 x 300mm
- 1x Slotted: 5.5 x 300mm
- 1x Pozidriv: PZ2 x 300mm

05347735002

**\$75**



## 160 i/168 i/6 Screwdriver Set & Rack 6pc

Includes:

- 162 i PH VDE Phillips Insulated Screwdrivers
- 160 i VDE Slotted Insulated Screwdrivers
- 168 i VDE Square Drive Insulated Screwdrivers
- Storage rack

05347777001

**\$69**



## Ratcheting Combination Wrench Set 11pc

Includes:

- 8 x 144mm
- 10 x 159mm
- 11 x 165mm
- 12 x 170.7mm
- 13 x 177mm
- 14 x 188mm
- 15 x 200mm
- 16 x 212mm
- 17 x 224mm
- 18 x 235mm
- 19 x 246mm

05020013001

**\$499**



## Joker Self-Setting Spanners 4pc

Sizes:

- 7-10mm/1/4-3/8", 10-13mm/7/16-1/2", 13-16mm/1/2-5/8", 16-19mm/5/8-3/4"

05020110001

**\$299**



## Adjustable Torque Screwdriver with Rapidaptor Quick-Release Chuck

Wera torque screwdriver. Kraffform pistol handle for particularly high torque transfer, multi-component for high working speeds and particularly ergonomic screwdriving. Variable torque setting option with highest precision.

05074702001

**\$239**



## 1/2" Dr. Wheel Impaktor C Socket Set 3pc

Includes:

- 1x 17 x 85 x 30mm Socket
- 1x 19 x 85 x 30mm Socket
- 1x 21 x 85 x 32mm Socket

05004595001

**\$89**



## Kraffform Kompakt Turbo i 16pc Imperial 1

Many users would like to be able to carry out screwdriving processes faster without compromise. With a screwdriver that is precise, allows powerful screwdriving, and is much faster than a conventional screwdriver.

05057485001

**\$259**



## Click-Torque Wrenches

Part No.	Description	Price
05075605001	A 6 2.5-25Nm 1/4" Dr.	\$419
05075623001	C 4 60-300Nm 1/2" Dr.	\$399



## Electricians Tool Set 73pc

Extensive 73-piece tool set in the compact Wera 2Go, 2 tool container, for electricians in mobile operations

05134025001

**\$1,699**



## 9700 Tool Rebel Roller Cabinet

Features:

- Exclusive roller cabinet in the Tool Rebel design
- Extremely robust thanks to a double-walled design
- 7 Drawers (5 flat, 2 high)
- 2 Flat drawers are equipped with foam inserts and tools (e.g. with Zyklop Speed ratchet and accessories, Joker spanners, Kraffform screwdrivers, L-keys)

Specifications:

Flat Drawers	522 x 81 x 398mm (WxHxD)
High Drawers	522 x 166 x 398mm (WxHxD)

Includes:

- 05150121001 - Foam Insert Socket & Accessory Set
- 05150101001 - Foam Insert Screwdriver Set
- 05150121001 - Foam Insert Joker Spanner Set
- 05150140001 - Foam Insert L-Key Set

05150130001

**\$4,599**



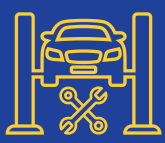

### Flaring Tool Kits

- Popular flaring tool quickly and accurately produces convex and double lap flares to SAE and DIN standards on automotive brake and clutch pipes
- Features a unique 'Dial-a-Size' turret design and lever cam operation for quick flaring
- Screw clamp for accurate die alignment and automatic punch extraction from flare provide the easiest of operation



**BASIC**

027001  
**\$775**

**MASTER**

027008  
**\$1,120**

**BASIC SAE & DIN**

027009  
**\$740**

### Specifications

Kit Part No.	Flare Pattern	Tube Outside Diameter									
		3/16"	1/4"	5/16"	3/8"	1/2"	4.75mm	6mm	8mm	10mm	12mm
027001	SAE Convex Single	•					•				
	SAE Double	•					•				
027008	SAE Convex Single	•	•	•	•	•	•	•	•	•	•
	DIN Convex Single						•				
027009	SAE Double	•	•	•	•	•	•	•	•	•	•
	DIN Convex Single						•				
027009	SAE Convex Single	•	•				•	•			
	DIN Convex Single						•				
027009	SAE Double	•	•				•	•			

### Air Assisted Caliper Piston Windback Tool

- Uses existing workshop compressed air applied to ram while rotating the handle to return the caliper piston with very little effort
- Suitable for both left hand and right hand screw applications
- 3/8" Sq. Dr.



**LIMITED STOCK!**

036198

**\$169**

### Ball Joint Separator HGV MECHANICAL SCREW

- Enables ball joint separation and removal on heavy goods vehicles
- Heavy duty manufacture with strengthened lever and fork allowing for greater force to be applied
- Manufactured from alloy steel SCM 440
- Jaw Opening: 70mm
- Throat Width: 36mm
- Throat Depth: 50mm



080700

**\$750**

### Butane Soldering Iron Kit 9 Piece

- Three features in one kit: Soldering Iron, Hot Torch & Hot Blower
- Includes 8 accessories and attachments for all soldering applications
- See-through viewing window provides an accurate level of remaining butane



680005

**\$135**

### Professional Diamond Tipped Mini Engraver

- Handy pocket engraver easily marks glass, ceramic, plastic and hardened metals
- Long lasting diamond tip
- Suitable for personalising toys, sport equipment, tools, appliances, gifts and trophies
- Includes 2x AAA batteries



680004

**\$60**

### Motorq Torque Wrenches



- Upgraded soft feel ergonomic handle provides exceptional grip even in oily conditions
- 60% larger easy to read dual scale for improved visibility, precise torque setting adjusts 40% faster
- Made in England

Part No.	Sq. Dr.	Torque Capacity		Length mm	PRICE
		Nm	Lbf.ft		
800060	3/8"	10 - 50	7.5 - 37.5	335	<b>\$399</b>
800101	1/2"	20 - 100	15 - 75	387	<b>\$399</b>
800200	1/2"	40 - 200	30 - 150	470	<b>\$450</b>
800300	1/2"	60 - 300	45 - 220	593	<b>\$490</b>
800330	1/2"	60 - 340	45 - 250	685	<b>\$540</b>

### Pocket LED Pen Light RECHARGEABLE

- Bright and robust pocket pen light for quick and easy illumination of dark work areas
- Lighting modes: Bottom Light with direct beam and Work Light with wide flood beam
- Inbuilt belt clip with magnet
- USB charging lead supplied



300600

**\$44**

### LED Work Light RECHARGEABLE

- Multifunctional work light for the professional user
- Lighting modes: Top Light with direct beam and work light with wide flood beam
- Super strong magnets and two 360° rotating hooks allow for hands free operation
- USB charging lead supplied



300601

**\$115**

### LED Slimline Work Light RECHARGEABLE

- Ultra-bright and lightweight slim work light illuminates hard to reach places with ease
- Lighting modes: Top Light with direct beam and work light with wide flood beam on adjustable dimmer switch
- 360° rotating swivel ball joint with super strong magnet and folding hook allows for hands free operation
- USB charging lead supplied



300602

**\$139**

### Motorq Torque Wrench HEAVY DUTY



**NEW Two piece split design**

- New Generation Motorq 2-piece split torque head and handle design is suitable for all heavy duty applications
- Made in England

Part No.	Sq. Dr.	Torque Capacity		Length mm	PRICE
		Nm	Lbf.ft		
802500	3/4"	300 - 1000	200 - 750	1449	<b>\$1,599</b>

### Foldable LED Slimlight RECHARGEABLE

- Handy foldable pocket pen light for quick and easy illumination of dark work areas
- Features three lighting modes: front fold out Flood Light with normal and eco modes, rear Flood Light and direct beam Top light
- USB charging lead supplied



300606

**\$89**

### Flood & Area Worklight RECHARGEABLE

- Multifunctional flood and area light suitable for use in workshops, building and camping
- Stepless dimmer switch easily adjusts the brightness from 60 - 1000 Lumens
- Built in power bank allows for the charging of smartphones and tablets
- USB charging lead supplied



300609

**\$159**

### Twin Leg Puller 350MM

- Two legs for removing gears, races, bearings
- Spread: 0-350mm
- Reach: 380mm
- Standard adjustable legs
- Supplied in metal case
- Made in England



083300

**\$595**

### Twin & Triple Leg Puller Kit 200MM

- Wide range of pulling options
- Spread: 0-200mm
- Reach: 140mm
- Double ended reversible legs
- No. of Puller Combinations: 4
- Supplied in metal case
- Made in England



082805

**\$490**

### Mechanical Puller & Separator Kit 200MM

- Makes 8 mechanical pullers with 2 separators options
- Double ended reversible legs for a wide range of pulling options
- Puller Reach: 140mm Max
- Puller Spread: 0 - 200mm Max
- External Spread: 105mm
- Supplied in metal case
- Made in England



084906

**\$1,150**

### Hydraulic Twin and Triple Leg Puller Kit 200MM

- Makes 6 different twin/triple leg pullers
- Spread: 50-200mm, Reach: 200mm
- Ram Extension: 50 & 100mm
- Supplied in metal case
- Made in England



155008

**\$1,120**

### Internal Extractor Kit 8 - 22.5MM

- Extract components quickly and efficiently when conventional pullers cannot be used
- Removes bearings, oil seals etc
- Twin beam pulling unit attachment available 095805
- Spread: 8 - 22.5mm
- Includes 4x split collet extractors
- Supplied in metal case

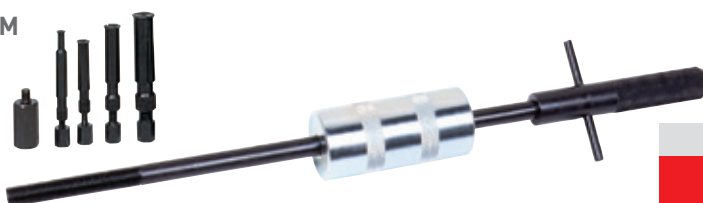

095804

**\$715**

### Hydraulic Separator Kit

- Versatile tool where a long reach is required
- The tapered edges of the bearing separator provide all round support and can fit behind bearings where normal puller legs cannot gain access
- Spread: 20-105mm, Reach: 876mm
- Ram Extension: 100mm
- Supplied in metal case
- Made in England



193100

**\$970**



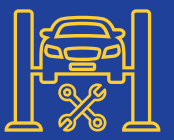

## Super Hollow Punch Sets

Part No.	Description	Price
6429	6-25mm, 10pc	<b>\$95</b>
6430	5-35mm, 14pc	<b>\$143</b>



## Punch and Chisel Holder

Firmly grips any tool shank up to 1" hex or 1.1/8" round. Makes control of punch or chisel easy.

5910  
**\$21**



## Dead Blow Hammers

Part No.	Description	Price
7042	520g (18oz)	<b>\$39</b>
7043	1,050g (36oz)	<b>\$63</b>



## Ball Pein Hammers

Part No.	Description	Price
7051	8oz	<b>\$28</b>
7053	16oz	<b>\$37</b>
7055	24oz	<b>\$41</b>
7056	32oz	<b>\$44</b>
7061	40oz	<b>\$58</b>



## Number and Letter Punch Sets 36pc

Part No.	Description	Price
8881A	3/16" 5mm	<b>\$75</b>
8882A	1/4" 6mm	<b>\$80</b>
8883A	5/16" 8mm	<b>\$155</b>
8884A	3/8" 10mm	<b>\$179</b>

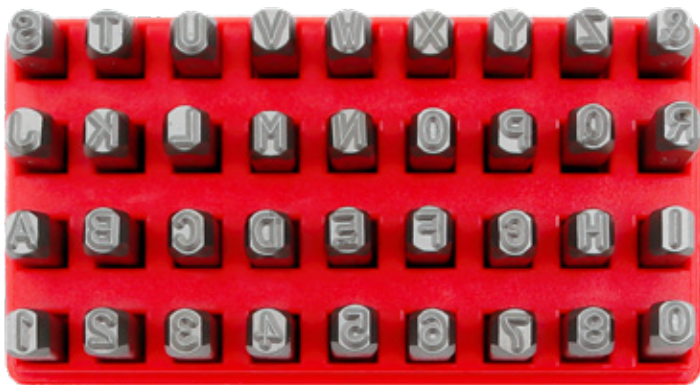

## Brass Punch

Part No.	Description	Price
8935	Brass Taper Drift Punch 10mm	<b>\$45</b>
8936	Brass Drift Set 2pc	<b>\$115</b>
J2605	Brass Pin Punch Set 5pc	<b>\$78</b>



## Punch Sets

Part No.	Description	Price
8244	Pin Punch Set 4pc	<b>\$44</b>
8294	Long Taper Punch Set 4pc	<b>\$93</b>



## Cold Chisel Sets

Part No.	Description	Price
8350	Cold Chisel Forged Molybdenum set 4pc	<b>\$93</b>
8379	Long 12" Cold Chisel Set 5pc	<b>\$85</b>
8412	Chisel/Punch Set 12pc	<b>\$72</b>

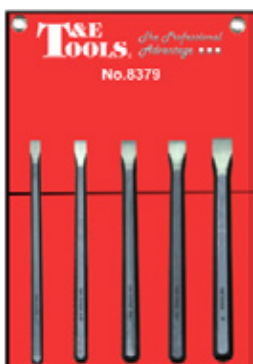

## Automatic Centre Punch

No hammering required just simply adjust tension screw to desired pressure, apply hand force and "pop" it's done.

8018  
**\$30**



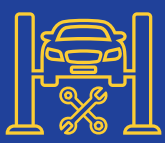

# T&E HAND TOOLS

## Stubby Combination Wrench Sets

Part No.	Description	Price
13110S	Metric 12pc	\$148
13009S	SAE 9pc	\$90



## Gear Ratchet Wrench Flex Head Set SAE 12pc

Sizes:  
• 5/16, 11/32, 3/8, 7/16, 1/2, 9/16, 5/8, 11/16, 3/4, 13/16, 7/8, 15/16 & 1"

13996

### \$409



## Flex-Head Gear Ratchet Wrench Set Metric 16pc

Sizes:  
• 10, 11, 12, 13, 14, 15, 16, 17, 18, 19, 21, 22, 24, 27, 30 & 32mm

13997A

### \$572



## Quad-Box Ratchet Wrench Sets

Part No.	Description	Price
13992	12 Sizes in 3, Metric 5-19mm	\$123
13994	8 Sizes in 2, SAE	\$83



## Gear Ratchet Wrench Double Ring Set Metric 6pc

Sizes:  
• 8 x 9, 10 x 11, 12 x 13, 14 x 15, 16 x 18 & 17 x 19mm

14106

### \$148



## Flare Nut Wrench Set in EVA Form Metric 6pc

Sizes:  
• 8 x 10, 9 x 11, 12 x 14, 13 x 15, 16 x 18 & 17 x 19mm

5068

### \$142



## Adjustable "C" & Pin Wrench Set 6pc 5459

### \$221



## Euro Combination Wrench Set Metric 26pc

Sizes:  
• 6, 7, 8, 9, 10, 11, 12, 13, 14, 15, 16, 17, 18, 19, 20, 21, 22, 23, 24, 25, 26, 27, 28, 29, 30 & 32mm

71026

### \$336

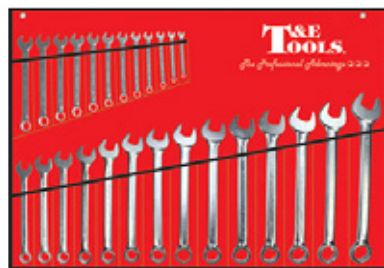

## Flare Nut Crowsfoot Wrench Sets

Part No.	Description	Price
93919	Metric 19pc	\$197
93916	SAE 16pc	\$164



## Crowsfoot Wrench Sets

Part No.	Description	Price
BCF55M	Open-End, Metric 15pc	\$123
BCF55	Open-End, SAE 11pc	\$123



## Flex Head Long Ring Gear Ratchet Wrench Set 6pc

Particularly useful for getting into hard to reach deep recessed areas where limited clearance doesn't allow the use of a socket set. Comes in a very practical EVA foam tray to keep the tools organised in your tool chest/cabinet.

Sizes:  
• 8 x 9, 10 x 11, 12 x 13, 14 x 15, 16 x 17 & 18 x 19mm

HPG6

### \$369



## Hi-Performance Long Ring Wrench Set 6pc

Extra long hi-performance flat double ended ring wrenches - Full mirror chrome finish and forged from 6140 alloy steel.

Sizes:  
• 10 x 11, 12 x 14, 13 x 15, 16 x 18, 17 x 19 & 22 x 24mm

HPR6

### \$270



## Half Moon Wrench Set 6pc

Designed to reach the hard to get at distributor, carburettor, manifold and air conditioning mounting bolts. Supplied in plastic display tray.

Sizes:  
• 6 x 9, 10 x 11, 14 x 12, 13 x 15, 17 x 19 & 16 x 18mm

M5800

### \$172



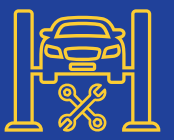

## Super Fine Stubby Ratchet Set 3pc

Extra fine ratchet action with 108 gear teeth ratchet swing arc of 3.3 degrees allowing faster work in the most confined of spaces. Sealed head with Forward and Reverse drive and manufactured from Chrome Vanadium.

21531

**\$118**



## Super Fine Flex-Head Ratchet Set 3pc

Extra fine ratchet action with 108 teeth, 3.3° swing allowing faster work in the most confined of spaces. Sealed head with Forward and Reverse drive and manufactured from Chrome Vanadium.

21532

**\$161**



## Super Fine Master Ratchet Set 3pc

Extra fine ratchet action with 108 teeth, 3.3 degrees swing allowing faster work in the most confined of spaces. Sealed head with Forward and Reverse drive and manufactured from Chrome Vanadium.

21533

**\$150**

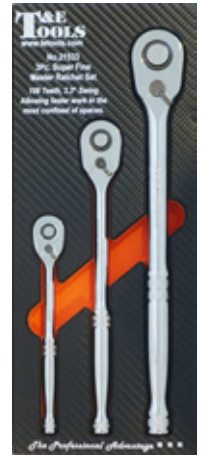

## Super Fine Extra Long Ratchet Set 3pc in EVA Tray

Extra long ratchets are designed for better access into deep recessed areas.

Includes:

- 1/4, 3/8 & 1/2" Drive Ratchets in EVA tray

21534

**\$237**

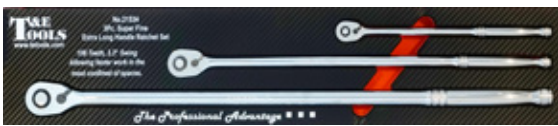

## Flex-Head Long Handle Ratchet Set 3pc

Includes:

- 1x 1/4" Dr. Flex-Head Long Handle Ratchet
- 1x 3/8" Dr. Flex-Head Long Handle Ratchet
- 1x 1/2" Dr. Flex-Head Long Handle Ratchet

21535

**\$254**



## Chrome Adaptor Set 6pc

Sizes:

- 1/4, 3/8, 1/2 & 3/4"

22345

**\$57**



## 1/2" Dr. 72T Adjustable Handle Ratchet

Features:

- Extendable length from 305-445mm
- Quick release

24695

**\$87**



## 1/2" Dr. 72T Flex Head Extendable Ratchet

Features:

- Extendable length from 345-495mm

24698

**\$106**



## Extra Long Hinge Bars

Part No.	Description	Price
28FH	1/2" Drive, 765mm	<b>\$93</b>
34FH	3/4" Drive, 1,020mm	<b>\$164</b>
35FH	1" Drive, 1,020mm	<b>\$197</b>



## SAE & Metric Socket Sets

Part No.	Description	Price
92674	73pc, 1/4" Drive	<b>\$165</b>
93748	56pc, 3/8" Drive	<b>\$213</b>
94639	36pc, 1/2" Drive	<b>\$264</b>



## 1/2" Dr. Ribe Socket Set 8pc

Sizes:

- M5, M6, M7, M8, M10, M12, M14 & M16

5080

**\$87**



## 1/2" Dr. Tamper-Torx Socket Set 7pc

Sizes:

- T30, T40, T45, T50, T55, T60 & T70

5803

**\$72**



## 1/2" Dr. In-Hex Socket Sets

Long series made from chrome alloy steel with S2 steel In-hex bits.

Part No.	Description	Price
94108	SAE - 1/8, 5/32, 3/16, 7/32, 1/4, 5/16, 3/8, 7/16, 1/2"	<b>\$106</b>
94109	Metric - 4, 5, 6, 7, 8, 9, 10, 12, 14mm	<b>\$106</b>



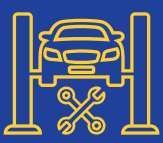

# SPECIALTY TOOLS

## 3/8" Dr. Torx-r Impact Socket Sets 7pc

Sizes:  
• T20, T25, T27, T30, T40, T45 & T50  
98801

### \$106



## Impact Socket Adaptors & Universal Joint Set 11pc

Includes:  
• 1/4" Drive Female x 3/8" Drive Male Impact Adaptor  
• 3/8" Drive Female x 1/4" Drive Male Impact Adaptor  
• 3/8" Drive Female x 1/2" Drive Male Impact Adaptor  
• 1/2" Drive Female x 3/8" Drive Male Impact Adaptor  
• 1/2" Drive Female x 3/4" Drive Male Impact Adaptor  
• 3/4" Drive Female x 1/2" Drive Male Impact Adaptor  
• 3/4" Drive Female x 1" Drive Male Impact Adaptor  
• 1" Drive Female x 3/4" Drive Male Impact Adaptor  
• 1/4" Drive Impact Universal Joint  
• 3/8" Drive Impact Universal Joint  
• 1/2" Drive Impact Universal Joint  
76348

### \$152



## In-Hex Impact Socket Sets 9pc

Part No.	Description	Price
94909M	Metric - Sizes: 4, 5, 6, 7, 8, 9, 10, 12 & 14mm	\$123
94909	SAE - Sizes: 3/16, 7/32, 1/4, 5/16, 3/8, 7/16, 1/2, 9/16 & 5/8"	\$140



## 3/4" Dr. In-Hex Impact Socket Sets

Part No.	Description	Price
98708	6pc SAE - Sizes: 5/8, 3/4, 13/16, 7/8, 15/16 & 1"	\$230
98706	6pc Metric - Sizes: 14, 17, 19, 22, 24 & 27mm	\$230



## 3/4" Drive Torx-r Impact Socket Set 4pc

Sizes:  
• T70, T80, T90, T100  
98804

### \$172



## 1/4", 3/8", 1/2" Dr. Impact Extension Bar Set 9pc

Made of chrome molybdenum steel.  
IE2349

### \$62



## 3/8" Dr. 6 Point Deep Impact Socket Set 13pc

Sizes:  
• 8, 9, 10, 11, 12, 13, 14, 15, 16, 17, 18, 19 & 21mm  
98313L

### \$156

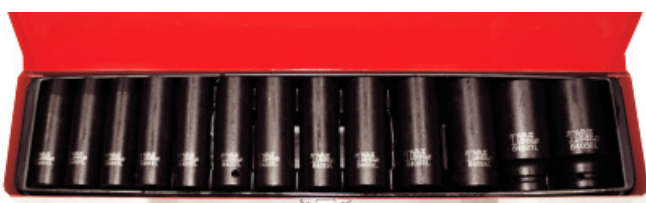

## 1/2" Dr. Impact Socket Sets 14pc

Part No.	Description	Price
98412A	Standard, 10-27mm	\$123
98413L	Deep, 10-30mm	\$126



## 3/4" Dr. Impact Socket Sets

Part No.	Description	Price
98515LA	Metric, Deep, 15pc, 19-50mm	\$630
98521A	Metric, Standard, 21pc, 19-60mm	\$712
97538	Female Torx, Deep, 5pc	\$230



# BATTERY CHARGERS & STARTERS

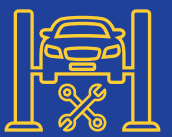

## 12V 5.0A Smart Charger

The GX Series Advanced Battery Chargers are designed for use with all types of 12V batteries. Compatible with WET, AGM, EFB, VRLA as well as 12.8V LiFePO4 Lithium batteries.

GX5

**\$122**



## 12V 10.0A Smart Charger

The GX Series Advanced Battery Chargers are designed for use with all types of 12V batteries. Compatible with WET, AGM, EFB, VRLA as well as 12.8V LiFePO4 Lithium batteries.

GX10

**\$267**



## 12/24V 15.0A Smart Charger

The GX Series Advanced Battery Chargers are designed for use with all types of 12V batteries. Compatible with WET, AGM, EFB, VRLA as well as 12.8V LiFePO4 Lithium batteries.

GX15

**\$320**



## 12/24V Lithium PowerPack/Jump Starter 1,200PA

This smart booster is sure to come in handy if you have a flat battery in your car, boat, motorcycle/ATV or farm machinery. The smart booster charges tablets, smartphones and other USB devices and has a 12V output suitable for cooling boxes and other 12V small appliances. It is also a powerful torch with hazard lights and SOS function.

X11

**\$724**



## 12V Lithium PowerPack/Jump Starter 500PA

An emergency backup power source to start a dead battery on a domestic vehicle. Keep in your glove box so it's always there when you may need it. Ideal for the car or for home as a power bank to charge and run mobile phones, laptops and other USB devices.

X7

**\$343**



## 12/24V Battery Tester and Electrical System Tester

Test battery charge/health for all 12V auto batteries and alternator/crank systems for 12/24V batteries, including new stop start batteries. Print test results using the built in printer.

T13

**\$670**



## How do Capacitor Boosters work?

The booster is equipped with so-called ultracapacitors, also known as capacitors. This system requires no maintenance and is charged by the residual voltage of the vehicle battery. The big advantage of this type of starter booster is that it has no battery, charging can be done by connecting the booster to the battery terminals of a running vehicle. It is therefore advisable to charge the booster on the battery of the vehicle after each use, so the booster is immediately ready for the next job. The charging time is on average 8 to 40 seconds, depending on the type of vehicle. Charging on mains voltage is also possible, the charging time differs per model and averages 3 to 8 hours. The booster always remains operational. Even after years of storage, it is ready to start after a short charging cycle.

The powerful start booster is very resistant and therefore suitable for all professional interventions and repairs. In addition, the booster does not lose power at extreme temperatures, the booster is protected against short circuit and polarity reversal, the booster is protected from peak points and the electronics of the vehicle are protected. The weight has been reduced to a maximum, which is why the booster can also be used as a portable energy source. Furthermore, the booster starts both petrol and diesel engines and the device checks the capacity of the vehicles alternator.

Part No.	Description	Price
C181200	12V Ultra Capacitor Start Booster	\$624
C1624V	24V PROCAP Truck Start Booster 6,000PA	\$1,903
C21224V	12/24V PROCAP Truck Start Booster Trolley 9,000PA	\$2,403
C2TR1224V	12/24V PROCAP Heavy Duty Truck Start Booster Trolley 9,500PA	\$2,735



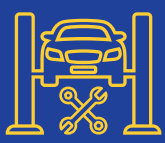

# VEHICLE LIFTING

**NEW NEW NEW**

**Handijack**  
MACHINERY

**NEW NEW N**

### 0.5T Transmission Jack

**Specifications:**

Capacity 0.5T  
Minimum Height 940mm  
Maximum Height 1,940mm  
Weight 64kg

HJ3321

**\$825**



**QUICK  
LIFT**

### 1T Transmission Jack

**Specifications:**

Capacity 1T  
Minimum Height 940mm  
Maximum Height 1,940mm  
Weight 72kg

HJ3332

**\$860**



**QUICK  
LIFT**

### Hydraulic Vehicle Positioning Jack

**Specifications:**

Capacity 1,500lb  
Stroke 280mm  
Working Range 340-620mm

HJ5201

**\$260  
EACH**

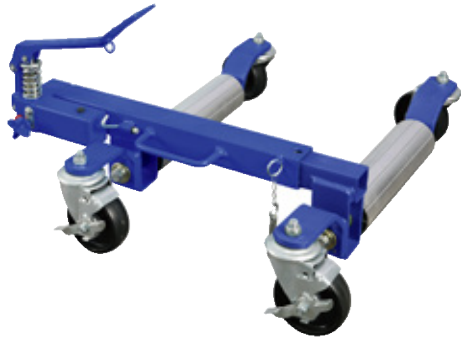

### 1100lbs Mini Motorcycle Lift

**Specifications:**

Capacity 1,100lb  
Minimum Height 90mm  
Maximum Height 405mm  
Weight 14kg

HJ1009

**\$173**



### 3 Tonne Trolley Jack - Professional

**Features:**

- Dual acting piston pumps for quick lifting
- Super Low Profile Design

**Specifications:**

Capacity 3 Tonne  
Minimum Height 75mm  
Maximum Height 425mm  
Length 685mm

HJ5610PA

**\$302**



### 20T Air/Hydraulic Shop Press

**Specifications:**

Capacity 20T  
Minimum Height 35mm  
Maximum Height 912mm

HJ0809CEA

**\$1,215**



### 30T Air/Hydraulic Shop Press

**Specifications:**

Capacity 30T  
Minimum Height 151mm  
Maximum Height 1,031mm

HJ0808CEA

**\$1,735**



### 50T Air/Hydraulic Shop Press

**Features:**

- Press bed raised & lowered by hand winch, lockable in any position
- Air over hydraulic with foot pedal operation

**Specifications:**

Capacity 50T  
Working Range 67-1,047mm  
Ram Stroke 200mm  
Bed Width 730mm  
Weight 345kg

HJ0811CE

**\$3,699**



### 75T Air/Hydraulic Shop Press

**Features:**

- Press bed raised & lowered by hand winch, lockable in any position
- Air over hydraulic with foot pedal operation

**Specifications:**

Capacity 75T  
Working Range 170-884mm  
Ram Stroke 250mm  
Bed Width 800mm  
Weight 498kg

HJ0812CE

**\$5,599**



### 100T Electric Shop Press

**Features:**

- Ram can be moved left or right
- Press bed raised & lowered by hand winch, lockable in any position

**Specifications:**

Capacity 100T  
Voltage 415V, 3 Phase  
Ram Stroke 300mm  
Weight 680kg

HJ0883

**\$11,500**



### 150T Electric Shop Press

**Features:**

- Ram can be moved left or right
- Press bed raised & lowered by hand winch, lockable in any position

**Specifications:**

Capacity 150T  
Voltage 415V, 3 Phase  
Ram Stroke 350mm  
Weight 1,125kg

HJ0884

**\$13,900**



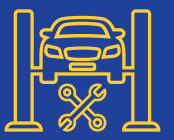

## Workshop Floor Fan 3 Speed 500mm

- Features:**
- Chrome finish industrial alloy blades

**Specifications:**

Power	230V/50Hz
Motor	180W
Cable Length	2.5m
Air Displacement	142m <sup>3</sup> /min
Fan Speed	1,350rpm
Sound Level	70 d(D)A

**FES50X**

**\$179**



**AUTO STAR**

## Workshop Pedestal Fan 3 Speed 750mm

- Features:**
- Chrome finish industrial alloy blades
  - Adjustable head and pole height

**Specifications:**

Power	230V/50Hz
Motor	280W
Cable Length	2.5m
Air Displacement	290cu m/min
Fan Speed	1,350rpm
Sound Level	86 d(D)A

**FS75**

**\$235**



**AUTO STAR**

## Workshop Wall Mounted Fan 3 Speed 750mm

- Features:**
- Chrome finish industrial alloy blades

**Specifications:**

Power	230V/50Hz
Motor	280W
Cable Length	1.5m
Air Displacement	290cu m/min
Fan Speed	1,350rpm
Sound Level	86 d(D)A

**FB75**

**\$195**



**AUTO STAR**

## 6" Bench Grinder and Sander with Work Light 250W

- The 2-in-1 250W bench grinder and sander has everything you need for sanding, grinding and sharpening
- Inbuilt work light
- Transparent, re positionable eye shields
- 150 x 25mm grinding wheel
- 50 x 686mm sanding belt

**HBGL650A**

**\$199**



**AUTO STAR**

## Bench Grinder 8" 750W

- Reliable and silent induction motor
- Accepts both wire wheel and grinding wheel
- Equipped with adjustable work rest and safety glass
- For the professionals and DIYers
- With cast iron motor housing and iron base
- Left: Coarse #36; Right: Fine #60 grinding wheels

**TDS-200H**

**\$300**

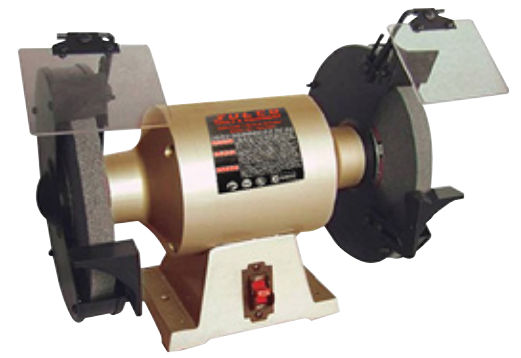

**AUTO STAR**

## Bench Grinder 10" 900W

- Reliable and silent induction motor
- Accepts both wire wheel and grinding wheel
- Equipped with adjustable work rest and safety glass
- For the professionals and DIYers
- With cast iron motor housing and iron base
- Left: Coarse #36; Right: Fine #60 grinding wheels

**RBG250I**

**\$395**



**AUTO STAR**

## Bench Grinder with Flexible Shaft, 75mm

- Perfect for deburring, grinding, and polishing small parts (wood, plastic, glass, brass, copper, jewellery etc)
- Eye safety Shield provides good protection during working
- Compact Design and easy to carry
- Comes with Ø75mm (80G) Grinding Wheel & a Ø75mm Polishing Wheel
- Flexible Shaft with Collet

**TDS75B**

**\$130**



**AUTO STAR**

## Bench Drill Presses

### 750W

**Specifications:**

Maximum Drilling Diameter	16mm
Motor Power	750W
Spindle Travel	85mm
Class of Speed	16
Speed 50/60Hz	180-2,770/220-3,320rpm
Spindle Taper	MT2
Height	1,000mm
Net/Gross Weight	55/57kg

**RDM2001B**

**\$640**



**AUTO STAR**

### 550W

**Specifications:**

Maximum Drilling Diameter	16mm
Motor Power	550W
Speed 50/60Hz	180-2,770/220-3,320rpm
Spindle Taper	MT2
Table Size	290 x 290mm
Height	1,600mm
Net Weight	70kg

**RDM2801FN**

**\$790**



### 1500W

**Specifications:**

Maximum Drilling Diameter	32mm
Motor Power	1500W
Speed 50/60Hz	150-2,450/180-2,940rpm
Spindle Taper	MT4
Table Size	360 x 360mm
Height	1,710mm
Net Weight	115kg

**RDM2811FN**

**\$1,550**



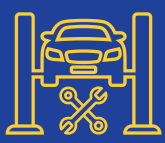

## 1/4" Dr. Socket Set 35pc Metric

- Includes:**
- Metric, Hex, Torx & Spline Sockets
  - 90T Sealed Head Ratchet
  - Flex Handle
  - Extension Bars
  - Universal Joint
- SP20116

# \$169



## 3/8" Dr. Socket Set 39pc Metric

- Includes:**
- Metric, Hex, Torx & Spline Sockets
  - 90T Sealed Head Ratchet
  - Flex Handle
  - Extension Bars
  - Universal Joint
- SP20216

# \$249



## 1/4" Dr. Socket Rail Sets

Part No.	Description	Price
SP20132	Metric, 10pc	\$29
SP20133	SAE, 9pc	\$25



## 3/8" Dr. Socket Rail Sets

Part No.	Description	Price
SP20232	Metric, 10pc	\$45
SP20233	SAE, 8pc	\$35



## 1/2" Dr. Socket Rail Sets

Part No.	Description	Price
SP20332	Metric, 12pc	\$75
SP20333	SAE, 11pc	\$65



## Socket Rail Sets

Part No.	Description	Price
SP20544	3/8", 100mm Spline, 7pc	\$69
SP20547	3/8", 100mm Metric INHEX, 7pc	\$69
SP20542	3/8", 100mm SAE INHEX, 7pc	\$69
SP20566	1/2", Metric Spline/INHEX, 13pc	\$99



## Wobble Extension Bar Sets

Part No.	Description	Price
SP21330	1/4", 3pc	\$29
SP22330	3/8", 3pc	\$39
SP23330	1/2", 3pc	\$79
SP20988	1/2" / 1/4" / 3/8", 9pc	\$99



## 1/2" Dr. Flex Handle Ratchet 375mm

- Features:**
- Hinged joint head
  - Soft grip handle
  - Chrome Vanadium Steel (Cr-V) for high durability
  - Meets & exceeds international ANSI & DIN standard
- SP23312

# \$49



## Metric & SAE Tool Kits

Part No.	Description	Price
SP51204	3/8", 65pc	\$329
SP51205	1/2", 60pc	\$349



## 3/8" Dr. Socket & Spanner Set E-Torx

SP20210

# \$119



## Spanner Sets

Part No.	Description	Price
SP10017	Combination Roe Quad Drive, Metric, 17pc	\$179
SP10011	Combination Roe Quad Drive, Metric, 11pc	\$139
SP10061	Combination Roe Quad Drive, SAE, 11pc	\$139
SP10001	Combination Roe Quad Drive, Metric & SAE, 18pc	\$199



## Double Ring Spanner Sets

Part No.	Description	Price
SP10136	Long 40° Offset Metric, 6pc	\$149
SP10185	Long 40° Offset SAE, 5pc	\$139



## Double Ring Spanner Set Long 9pc

- Sizes:**
- Metric, 8 x 9, 10 x 11, 12 x 13, 14 x 15, 16 x 17, 18 x 19, 20 x 22, 21 x 23 & 24 x 26mm
- SP10429

# \$199



## Gear Drive Spanner Sets

Part No.	Description	Price
SP10111	Roe Quad Drive, 15° Offset, Metric, 11pc	\$279
SP10212	Roe Quad Drive, 0° Offset, Metric, 12pc	\$239
SP10262	Roe Quad Drive, 0° Offset, SAE, 12pc	\$299





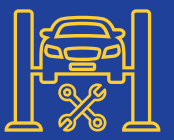

## 1/2" Dr. Impact Socket Sets

Part No.	Description	Price
SP20322	Metric, 40pc	<b>\$349</b>
SP20327	SAE, 34pc	<b>\$329</b>



## 1/2" Dr. Impact Socket Sets

Part No.	Description	Price
SP20320	Deep, Metric, 15pc	<b>\$189</b>
SP20325	Deep, SAE, 14pc	<b>\$189</b>



## 3/8" Dr. Impact Twist Socket Set 12pc

Sizes:  
• 8, 10, 11, 12, 13, 14, 15, 16, 17, 18 & 19mm  
SP31260

**\$159**



## 3/4" Dr. Impact Socket Sets

Part No.	Description	Price
SP20410	Metric, 8pc - 24-46mm	<b>\$229</b>
SP20415	SAE, 8pc - 1-1.1/2"	<b>\$229</b>
SP20420	Deep, Metric, 8pc	<b>\$299</b>
SP20425	Deep, SAE, 8pc	<b>\$299</b>



## Impact Socket Rail Sets

Part No.	Description	Price
SP20250	3/8" Dr. Metric, 10pc	<b>\$59</b>
SP20255	3/8" Dr. Stubby, Metric, 10pc	<b>\$69</b>



## Impact Socket Rail Sets

Part No.	Description	Price
SP20350	1/2" Dr. Metric, 11pc	<b>\$99</b>
SP20351	1/2" Dr. SAE, 11pc	<b>\$99</b>



## 1/2" Dr. Impact Socket Rail Set Wheel Nut Metric 5pc

Sizes:  
• 14, 17, 19, 21 & 22mm  
SP20390

**\$69**



## 1/2" Dr. Angular Torque Gauge SP35360

**\$35**



## Torque Wrenches - Micrometer

Part No.	Description	Price
SP35152	1/4" Dr. 323mm 5-25Nm	<b>\$169</b>
SP35252	3/8" Dr. 400mm 20-100Nm	<b>\$199</b>
SP35352	1/2" Dr. 517mm 40-200Nm	<b>\$209</b>
SP35353	1/2" Dr. 517mm 60-340Nm	<b>\$229</b>
SP35463	3/4" Dr. 918mm 110-550Nm	<b>\$849</b>
SP35473	3/4" Dr. 1,210mm 150-750Nm	<b>\$949</b>



## Torque Wrenches - Digital

Part No.	Description	Price
SP35155	Stubby, 1/4" Dr. 216mm 1-20Nm	<b>\$509</b>
SP35255	Stubby, 3/8" Dr. 290mm 4.2-85Nm	<b>\$549</b>
SP35355	1/2" Dr. 530mm 10-200Nm	<b>\$619</b>
SP35356	1/2" Dr. 650mm 17-340Nm	<b>\$629</b>



## Professional Bit Set 37pc SP39610

**\$99**



## Bit Sets

Part No.	Description	Price
SP39625	1/4", 3/8" & 1/2" Dr. Socket Bit Set, Hex & Torx, Metric/SAE, 84pc	<b>\$249</b>
SP34035	Impact Driver Bit Set, 1/2" Dr. Heavy Duty 10pc	<b>\$85</b>



## Key Sets

Part No.	Description	Price
SP34531	Stubby Hex Keys Metric 9pc - 1.5, 2, 2.5, 3, 4, 5, 6, 8 & 10mm	<b>\$29 EACH</b>
SP34532	Stubby Hex Keys SAE 9pc - 1/16, 5/64, 3/32, 1/8, 5/32, 3/16, 1/4, 5/16 & 3/8"	
SP34537	Stubby Tamper Proof Torx Keys 9pc - T-10, T-15, T-20, T-25, T-27, T-30, T-40, T-45 & T-50	
SP34511	Chrome Mag Hex Keys Metric Ball Drive 9pc - 1.5, 2, 2.5, 3, 4, 5, 6, 8 & 10mm	<b>\$45 EACH</b>
SP34512	Chrome Mag Hex Keys SAE Ball Drive 9pc - 1/16, 5/64, 3/32, 1/8, 5/32, 3/16, 1/4, 5/16 & 3/8"	
SP34517	Chrome Mag Torx Keys 9pc - T10, T15, T20, T25, T27, T30, T40, T45 & T50	<b>\$59 EACH</b>
SP34521	Chrome Hex Keys Metric Ball Drive 13pc - 1.27, 1.5, 2, 2.5, 3, 4, 4.5, 5, 5.5, 6, 7, 8 & 10mm	
SP34522	Chrome Hex Keys SAE Ball Drive 13pc - 0.05, 1/16, 5/64, 3/32, 7/64, 1/8, 9/64, 5/32, 3/16, 7/32, 1/4, 5/16 & 3/8"	



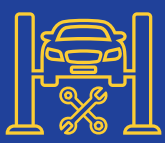

## Mechanic Creepers

Heavy duty steel frame, 6 heavy duty wheels, padded body & head rest.

Part No.	Description	Price
SPR-48	Size: 540 x 1,030mm (WxL)	<b>\$149</b>
SPR-44	Size: 440 x 1,030mm (WxL)	<b>\$119</b>



## Workshop Mobile Seats & Stools

Part No.	Description	Price
SPR-50	Workshop Seat Heavy Duty	<b>\$179</b>
SPR-55	Stool with Storage Pneumatic	<b>\$159</b>



## CAN OBDII/EOBD/JOB Scanner Code Reader

- Features:**
- Reads and clears generic and manufacturer specific diagnostic trouble codes (DTC's) and turns off check engine light
  - Wider vehicle coverage with CAN protocol support

SP61155

**\$235**



## Video Borescope 6mm Camera

- Features:**
- 3.2" colour TFT LCD screen
  - 1m long flexible, waterproof gooseneck imager head that easily performs visual inspections in hard to reach areas
  - High visibility and 10° adjustable LED lighting
  - Supports audio and video recording

SP70935

**\$499**



## Self-Igniting Professional Gas Soldering Torch Kit

- Features:**
- Cordless butane gas soldering iron with interchangeable tips
  - Ideal for various applications in automotive repairs, electrical/electronic circuit repair, light gauge welding, brazing and jewellery industries.
  - Refillable butane gas soldering iron

SP32290

**\$99**



## Infrared Laser Guided Thermometer

- Features:**
- Dual laser technology (twin dots)
  - Rapid detection function
  - Automatic data hold

SP62020

**\$229**



## Laser Actuated Tachometer

- Features:**
- rpm range 2.5-99,999
  - Non contact measurement of rpm
  - Memory function
  - 50-2,000mm range with reflective tape

SP62030

**\$115**



## Grease Gun

- Features:**
- 20" flexible hose with heavy duty quick release coupler
  - In-line swivel joint, eliminating awkward twisting
  - 2-way loading: Bulk or 450cc grease cartridge
  - Air inlet: 1/4"

SP65108

**\$149**



Also Available  
SP65104G Replacement Grease Tube **\$13**

## Wire Cutter & Stripper

- Features:**
- Strips and cuts cable or wire 10, 12, 14, 16, 18 & 22 AWG
  - ISO 5.5, 4.0, 2.5, 1.5, 1.0, 0.75mm

SP32272

**\$25**



## Ratchet Crimper 0.5 - 6mm

- Features:**
- 220mm hand ratchet crimper for pre-insulated terminals
  - Quick release action

SP32286

**\$49**



## Brake Pipe Bending Tool

Provides two size bend options for accurate and safe shaping of automotive brake pipes, up to 5mm in diameter.

SP63012

**\$29**



## Petrol Compression Tester Kit

- Features:**
- Easy reading 2-5" gauge features colour coated quadruple calibrations
  - 13" durable rubber hose with 14/18mm adapter
  - 6" Heavy duty stem with universal rubber cone adapter fits all plugs

SP66024

**\$89**



## Diesel Compression Tester Set Deluxe

- Features:**
- Suits direct & indirect diesel injected cars
  - Flexible hose (355mm) gives access to restricted plug & injector ports
  - Dual scale 80mm gauge 0-1000 psi and 0-70 Bar

SP66038

**\$349**



## Diesel Injector Seat Cleaner Set 7pc

- Features:**
- Five diesel injector seat cleaners, centering pilot and t-handle
  - Used to clean/de-carbonise injector seats

SP66084

**\$169**



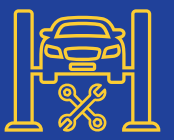

## SHOCKWAVE™ PACKOUT™ Impact Driver Bit Set 100pc

The MILWAUKEE® SHOCKWAVE™ Impact Duty driver bits are engineered to be the most durable, best fitting driver bits on the market. The optimised Shockzone geometry is unique for each tip type to provide up to 30x longer life and absorb 3x more torque vs. other impact bits.

48324050

**\$133**



**REDEEM™**  
SHOCKWAVE™ 32pc Mini Set  
4932464240  
\*Valid 01.01.2024 - 21.02.2024

## SHOCKWAVE™ Power Bit Security Torx 50mm (2") Set 8pc

Our SHOCKWAVE™ Impact Driver Bits are engineered to be the most durable, best fitting driver bits from MILWAUKEE®. The WEAR GUARD TIP™ delivers increased wear resistance which protects your impact bit's fit over the life of the bit.

48324689

**\$27**



## SHOCKWAVE™ Red Helix Titanium Drill Bit Rivet Set 8pc

MILWAUKEE® SHOCKWAVE™ Impact Duty Titanium Drill Bits with RED HELIX are engineered for impacts and drills. Designed with a Variable Helix with an aggressive 35° Helix Angle which ends at 15°, the Impact Duty Titanium Drill bits with RED HELIX provide Rapid Chip Removal to limit heat buildup to stay sharper longer.

48894868

**\$19**



## SHOCKWAVE IMPACT DUTY™ 1/2" Dr. 3pc Lug Nut Wheel Socket Set

Lug Nut Wheel Sockets feature a durable, non-marring sleeve to protect rims during tire changes. ARMOR-GUARD™ Sleeve is made with premium, durable plastic to withstand regular wheel installation and removals.

Includes:

• Sizes: 17, 19 & 21mm

49667830

**\$55**



## SHOCKWAVE™ Mini Bit Set 32pc

The MILWAUKEE® SHOCKWAVE™ Impact Duty driver bits are engineered to be the most durable, best fitting driver bits on the market. The optimised Shockzone geometry is unique for each tip type to provide up to 30x longer life and absorb 3x more torque vs. other impact bits.

4932464240

**\$25**



## SHOCKWAVE™ Impact Dr. Set 50pc

MILWAUKEE® SHOCKWAVE IMPACT DUTY™ Driver Bits are engineered for extreme durability and up to 50x Life. Made from proprietary steel and heat treated to control hardness, the Shockwave Impact Duty Driver Bits feature an innovatively designed geometric shock absorption zone to extend life.

48324024

**\$66**



## 9pc Snap Ring Pliers Set

Features an all-metal dial that quickly switches between internal and external modes. The all-metal dial is more durable than competitors. The anti-slip dial makes it easier to convert the pliers when working with both internal and external snap rings.

48226539

**\$252**



**NEW!**

## 2pc Long Reach Hose Grip Pliers Set

The 13" Long Reach Pliers Set provides the best access and maximum gripping force\*. The MILWAUKEE® Long Reach Pliers set includes 1x Straight Nose Plier and 1x 45° Nose Plier.

48226542

**\$99**



**NEW!**

## SHOCKWAVE™ Comprehensive Drill and Dr. Set 86pc

Features a range of bits designed which specifically cater towards the ANZ market. Each impact drill and driver bit features a Wear Guard Tip™ that delivers increased wear resistance which protects the fit over the life of the bit.

48325105

**\$156**



## SHOCKWAVE™ RED HELIX™ Titanium Bit Kit 19pc

Sizes:

• 2, 2.5, 3, 3, 3.5, 4, 4, 4.5, 5, 5.5, 6, 6.5, 7, 7.5, 8, 8.5, 9, 9.5 & 10mm

48894860

**\$99**



## RED HELIX™ Cobalt Drill Bit Kit 25pc

Sizes:

• 1, 1.5, 2, 2.5, 3, 3.5, 4, 4.5, 5, 5.5, 6, 6.5, 7, 7.5, 8, 8.5, 9, 9.5, 10, 10.5, 11, 11.5, 12, 12.5 & 13mm

48892531

**\$267**



## 3/8" Dr. Spark Plug Sockets

The MILWAUKEE® range of 6-point Spark Plug Sockets has been designed from the ground up to be part of the most versatile spark plug socket family. The chrome spark plug sockets are made with knurling to give you extra precise control and grip in specific applications.

Part No.	Description	Price
48229550	3/8" Dr. 9/16"	\$11
48229551	3/8" Dr. 5/8"	\$11
48229553	3/8" Dr. 13/16"	\$18



## 3/8" Dr. Magnetic Spark Plug Sockets

Stamped sizes for better visibility, precision control - knurled socket, rare earth magnets- easy installation & removal of Spark Plugs and secure rubber retainer.

Part No.	Description	Price
48229552	3/8" Dr. 5/8"	\$16
48229554	3/8" Dr. 13/16"	\$16



## 3/8" Dr. Spark Plug Sockets

Stamped sizes for better visibility, precision control knurled socket and secure rubber retainer.

Part No.	Description	Price
48229555	3/8" Dr. 14mm	\$12
48229556	3/8" Dr. 18mm	\$10



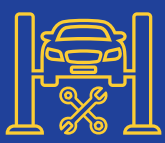

# MILWAUKEE® HAND TOOLS

## Mini Flush Cutters

Milwaukee® Mini Flush Cutters produce consistent, precise cuts through thin wires and cable ties. The spring-loaded cutter design helps to reduce fatigue while using the tool. The slim profile allows you to access tight spaces better.

48226105

**\$24**



## 14-IN-1 Ratcheting Multi-Bit Screwdriver

The Milwaukee® 14-in-1 Ratcheting Multi-Bit Screwdriver is a very versatile multi-bit screwdriver. This multi-bit driver features easy-access in-handle storage which keeps bits organized, allowing you to quickly change bit sizes and types. The durable, all-metal ratchet allows for higher torque and faster driving. The chrome-plated bit holder provides rust protection and reduces wear from elements on the jobsite. The Milwaukee® 14-in-1 Ratcheting Multi-Bit Screwdriver is backed by Milwaukee's Limited Lifetime Warranty.

48222903

**\$38**



## 4-IN-1 Precision Multi-Bit Screwdriver

Our Milwaukee® 4-in-1 Precision Multi-Bit screwdriver is more versatile and has better control for driving and precise tuning. This multi-bit driver features a 360-degree rotating back cap which offers greater control for speed and precision on the jobsite. It also has a comfortable, non-slip grip for maximum control. The two double-sided bits are stored neatly in the removable shank for quicker bit switches. The chrome-plated bit holder provides rust protection and reduces wear from elements on the jobsite. Our Milwaukee® 4-in-1 Multi-Bit Screwdriver is backed by our Limited Lifetime Warranty.

48222930

**\$19**



## Steel Ball Peen Hammers

### Features:

- SHOCKSHIELD™ grip - reduced peak vibration
- Smooth face - striking chisels and punches
- I-Beam handle
- Precision balanced
- Ball peen face -shaping metal

Part No.	Description	Price
48229130	16oz	<b>\$56</b>
48229131	24oz	<b>\$62</b>



## 15pc Ratcheting Combination Wrench Set Metric

### Includes:

- Sizes: 8-22mm (1mm increments)

48229516

**\$470**



## Pipe Wrenches

Part No.	Description	Price
48227171	Steel Offset Hex 66mm Jaw Capacity	<b>\$60</b>
48227215	Aluminium with POWERLENGTH™ Handle 14"	<b>\$110</b>



## 8-IN-1 Ratcheting Compact Multi-Bit Screwdriver

The Milwaukee® 8-in-1 Compact Ratcheting Multi-Bit Screwdriver is a very versatile multi-bit screwdriver. This multi-bit driver features easy-access in-handle storage, which keeps bits organized and allows you to quickly change bit sizes and types. The durable, all-metal ratchet allows for higher torque and faster driving. This multi-bit also driver has a removable bit holder so the bit can go directly into the handle in the tightest of spaces. The chrome-plated bit holder provides rust protection and reduces wear from elements on the jobsite. The Milwaukee® 8-in-1 Ratcheting Compact Multi-Bit Screwdriver is backed by Milwaukee's Limited Lifetime Warranty.

48222913

**\$30**



## Dead Blow Hammers

### Features:

- Steel reinforced handle
- Precision balanced
- Durable grip - resistant to peeling when exposed to solvents
- Overmold grip - greater comfort and grip

Part No.	Description	Price
48229150	28oz	<b>\$56</b>
48229151	48oz	<b>\$84</b>



## Dead Blow Ball Peen Hammers

### Features:

- Smooth face - striking chisels and punches
- Steel reinforced handle
- Precision balanced
- Durable grip - resistant to peeling when exposed to solvents

Part No.	Description	Price
48229140	16oz	<b>\$98</b>



## Double End Flare Nut Sets

The Milwaukee® Double End Flare Nut Wrench Set offers easy identification with ink-filled size labels for quick distinction between SAE and metric wrenches. Our slim profile open ends provide better access to hard-to-reach line nuts and hex bolt heads. The Comfortable I-Beam Handle Design allows superior user comfort, even while applying high torque.

Part No.	Description	Price
48229470	SAE - 5pc	<b>\$85</b>
48229471	Metric - 6pc	<b>\$90</b>





## High Performance Polarised Safety Glasses

The safety glasses feature a removable gasket that protects your eyes against debris. For added protection, the protective eye wear features anti-fog lenses so the lenses will stay clear and unobstructed on any jobsite.

48732945

**\$52**



## Performance Clear Safety Glasses

Our Performance Safety Glasses are designed with Anti-Fog & Anti-Scratch lenses. The protective eye wear features fog-free lenses so the lenses will stay clear and unobstructed on any jobsite.

48732920

**\$22**



## 10pc Screwdriver Kit

**Includes:**

- Phillips - PH1 x 76, PH2 x 38, PH2 x 101, PH6 x 152mm DEMO & PH2 x 152mm
- Slotted - 1/4" x 38mm, 1/4" x 101mm, 3/16" x 152mm, 5/16" x 152mm DEMO & 5/16" x 152mm

48222714

**\$63**



## Pry Bar 4pc Set

The MILWAUKEE® Pry Bar Set features an I-Beam Design for up to 40% More Prying Strength. The All-Metal Core and Hammer-Ready Strike Cap increase leverage and durability. Each pry bar has a Comfort Tri-Lobe Handle, as well as a Chrome Finish for superior corrosion resistance. The 4pc Pry Bar Set comes in an Easy-Access Tray for a long-term storage solution.

48229214

**\$111**

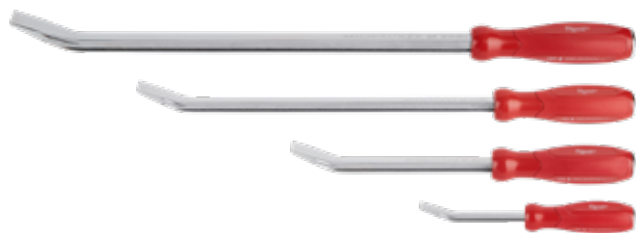

## 1/4" Dr. Ratchet & Socket Set 50pc SAE & Metric

**Includes:**

- 1/4" Dr. Standard Sockets 6pt Metric: 5.5, 6, 7, 8, 9, 10, 11, 12, 13, 14, 15mm
- 1/4" Dr. Deep Sockets 6pt Metric: 5.5, 6, 7, 8, 9, 10, 11, 12, 13, 14, 15mm
- 1/4" Dr. Standard Sockets 6pt SAE: 5/32, 3/16, 7/32, 1/4, 9/32, 5/16, 11/32, 3/8, 7/16, 1/2, 9/16"
- 1/4" Dr. Deep Sockets 6pt SAE: 5/32, 3/16, 7/32, 1/4, 9/32, 5/16, 11/32, 3/8, 7/16, 1/2, 9/16"
- 1/4" Dr. Extension: 75mm, 150mm
- 1/4" Dr. 90-Tooth Ratchet
- 1/4" Dr. Universal Joint

48229004

**\$192**



## 1/4" Dr. Ratchet & Socket Set 28pc Metric

Standard and deep sockets plus ratchet and accessories in a durable tray and carry case. Lifetime Guarantee.

**Includes:**

- 1/4" Dr. Standard Sockets 6pt - 5, 5.5, 6, 7, 8, 9, 10, 11, 12, 13, 14, & 15mm
- 1/4" Dr. Deep Sockets 6pt - 5, 5.5, 6, 7, 8, 9, 10, 11, 12, 13, 14, & 15mm
- 1/4" Dr. 90-Tooth Ratchet
- 1/4" Dr. Extensions - 75mm, 150mm
- 1/4" Dr. Universal Socket

48229504

**\$134**



## 3/8" Dr. Ratchet & Socket Set 56pc, SAE & Metric

**Features:**

- FOUR FLAT™ Sides on socket deter rolling
- FOUR FLAT™ Sides feature wrench-ready design
- 90T design with 4 degrees of arc swing for tight spaces
- Removable inner tray specifically designed to be integrated into steel storage units
- Slim profile head with flush direction lever
- Stamped Socket Sizes Portable Carrying Case

48229008

**\$290**



## 3/8" Dr. Ratchet & Socket Set 32pc Metric

Our Milwaukee® Metric 32pc 3/8" Dr. Ratchet & Socket set is designed from the ground up, offering our users the Most Versatile Sockets that are Anti-Roll and Wrench-Ready.

**Includes:**

- 3/8" Dr. Standard Sockets 6pt - 6, 7, 8, 9, 10, 11, 12, 13, 14, 15, 16, 17, 18, 19mm
- 3/8" Dr. Deep Sockets 6pt - 6, 7, 8, 9, 10, 11, 12, 13, 14, 15, 16, 17, 18, 19mm
- 3/8" Dr. 90-Tooth Ratchet
- 3/8" Dr. Extensions - 75, 150mm
- 3/8" Dr. Universal Joint

48229508

**\$175**



## 1/2" Dr. Socket Wrench Set 28pc Metric

**Includes:**

- 1/2" Dr. Standard Sockets 6pt - 10, 11, 12, 13, 14, 15, 16, 17, 18, 19, 20, 21, 22, 23, & 24mm
- 1/2" Dr. Deep Sockets 6pt - 10, 11, 12, 13, 14, 15, 16, 17, 18, & 19mm
- 1/2" Dr. 90-Tooth Ratchet
- 1/2" Dr. Extensions - 75, 125mm

48229510

**\$312**



## 1/2" Dr. Socket Set 47pc SAE & Metric

**Features:**

- FOUR FLAT™ Sides Feature wrench-ready design
- Removable inner tray specifically designed for steel storage
- Stamped socket sizes
- FOUR FLAT™ Sides on socket deter rolling
- 90T design with 4 degrees of arc swing for tight work spaces
- Slim profile head with flush direction lever
- Portable carrying case

48229010

**\$490**



## SHOCKWAVE™ 1/2" Dr. 29pc Metric Deep Impact Socket Set

The MILWAUKEE® 29pc SHOCKWAVE Impact Duty™ 1/2" Drive Deep Socket Set features the boldest, longest-lasting markings and extreme impact durability in high torque applications.

**Includes:**

- Sizes: 8-32mm (1mm increments)

49667015

**\$360**



## SHOCKWAVE™ Impact Socket Sets

Part No.	Description
49667018	3/4" Dr. SAE - 8pc Set: 1, 1.1/16, 1.1/8, 1.1/4, 1.5/16, 1.3/8, 1.7/16 & 1.1/2"
49667055	3/4" Dr. Metric - 8pc Set: 21, 22, 24, 27, 28, 32, 36, & 41mm

**\$245 EACH**



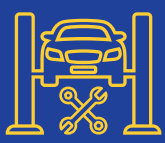

# MILWAUKEE® PACKOUT™

## Auto PACKOUT™ Stack

### Includes:

- PACKOUT™ Dolly
- PACKOUT™ 2-Drawer Tool Box
- PACKOUT™ 3-Drawer Tool Box
- PACKOUT™ Customisable Work Top

PKOAUTOKIT1

# \$999



## PACKOUT™ Large Wall Plate

Fully customise your workshop, garage or vehicle with the PACKOUT™ Large Wall Plate. With an impact-resistant polymer construction and fifteen metal-reinforced mounting points, the mounting plate has a strong and secure connection to the mounting surface and can take knocks and hits with ease.

48228487

# \$91



## PACKOUT™ Racking Kit

Our PACKOUT™ Racking Kit includes two PACKOUT™ racking shelves and two 508mm lengths of E-Track that allow you to attach and mount your racking system to a wide variety of surfaces: including your vans, trucks, trailers, garages, and shops.

48228480

# \$272



## PACKOUT™ Tool Box Rolling

The foundation for a PACKOUT™ storage solution that all other boxes connect to. With 225mm all-terrain wheels and industrial grade extension handle, this tool box can support loads of up to 113kg and easily travel across a variety of rough surfaces.

### Features:

- Metal reinforced corners
- Impact resistant polymer construction
- IP65 Rated

48228426

# \$450



## PACKOUT™ 3 Drawer Tool Box

Provides easy access to your tools no matter where the tool box is located in the stack.

### Specifications:

Weight Capacity 22.5kg total

48228443

# \$410



## PACKOUT™ 2 Drawer Tool Box

Provides easy access to your tools not matter where the tool box is located in the stack.

### Specifications:

Weight Capacity 22.5kg total

48228442

# \$370



## PACKOUT™ Large Tool Box

Users can also choose to utilise the PACKOUT™ Large Tool Box or PACKOUT™ Tool Box to securely stack and transport on top of the PACKOUT Rolling Tool Box.

### Features:

- Impact Resistant Polymer Construction
- Metal Top Handle
- Internal Organisation Tray

48228425

# \$230



## PACKOUT™ Organiser

### Features:

- Part of the PACKOUT™ System
- Connects to all Milwaukee® PACKOUT™ modular storage
- IP65 rated seal helps prevent damage from water and job site debris

### Specifications:

Dimensions 480 x 390 x 110mm (LxWxH)

48228430

# \$135



## PACKOUT™ Crate

The PACKOUT™ Crate is part of the industry's most versatile and durable modular storage system. The tool crate is made from impact resistant polymers to withstand drops and harsh job site conditions.

### Specifications:

Weight Capacity 22kg

Dimensions 270 x 390 x 240mm (LxWxH)

48228440

# \$110



## PACKOUT™ Compact Organiser

### Features:

- Perfect for secure storage of small items
- Items stay inside each bin when lid is closed
- Includes 4 small and 1 large bin plus dividers
- Clear lid for easy identification of contents
- Reinforced hinge & heavy duty latches
- IP65 Rated Weather Seal

48228435

# \$70



## PACKOUT™ Low-Profile Organiser

### Features:

- Slim Design for Organization of Small Items
- Connects to all Milwaukee® PACKOUT™ modular storage
- Integrated Center Slot For Long Bits and Blades

### Specifications:

Dimensions 501 x 248 x 64mm (LxWxH)

48228431

# \$138



## PACKOUT™ Tool Box XL

### Features:

- New to the PACKOUT™ range, with extra large storage inside for more
- Milwaukee Power Tools & Hand Tools
- IP65 rated protection
- Tote tray included

### Specifications:

Tool Capacity 45kg

48228429

# \$240





## PACKOUT™ XL Cooler

The PACKOUT™ Modular Storage System is the industry's most durable and versatile storage system. The PACKOUT™ XL cooler keeps ice for up to 5 days. The PACKOUT™ XL Cooler has been constructed with impact-resistant polymers for ultimate jobsite durability. This cooler is IP65 rated to withstand harsh environments and jobsite debris. This cooler comes with an integrated bottle opener, interior storage tray, and a food-grade cutting board/divider for maximum versatility on and off the jobsite. The MILWAUKEE® PACKOUT™ Modular Storage System allows you to customise a storage system that easily transports and organises your tools and accessories.

48228462

**\$419**



## PACKOUT™ Hard Sided Cooler

Our PACKOUT™ Modular Storage System is the industry's most durable and versatile storage system. The PACKOUT™ Hard Sided Cooler holds ice for up to 30 hours, and we've constructed it with impact-resistant polymers for ultimate jobsite durability.

48228460

**\$146**



## PACKOUT™ Backpack

Our PACKOUT™ Modular Storage System is the industry's most durable and versatile storage system. The PACKOUT™ Backpack has an impact-resistant molded base that you can connect with other PACKOUT system components via integrated locking cleats.

48228301

**\$240**



## PACKOUT™ Tote 254mm

Unique to the MILWAUKEE PACKOUT™ Modular Storage System is the integration of soft storage totes designed to attach to the top of any PACKOUT™ storage box or organiser. This allows users to not only attach a storage tote to the top of their PACKOUT™ system for transport, but also gives the flexibility to attach an organiser to the bottom of a tote for quick tasks that only require a few hand tools and small fasteners.

48228310

**\$120**



## PACKOUT™ Tote 381mm

Unique to the MILWAUKEE® PACKOUT™ Modular Storage System is the integration of soft storage totes designed to attach to the top of any PACKOUT™ storage box or organiser. This allows users to not only attach a storage tote to the top of their PACKOUT™ system for transport, but also gives the flexibility to attach an organiser to the bottom of a tote for quick tasks that only require a few hand tools and small fasteners.

48228315

**\$180**



## PACKOUT™ Tote 508mm

Unique to the MILWAUKEE PACKOUT™ Modular Storage System is the integration of soft storage totes designed to attach to the top of any PACKOUT™ storage box or organiser. This allows users to not only attach a storage tote to the top of their PACKOUT™ system for transport, but also gives the flexibility to attach an organiser to the bottom of a tote for quick tasks that only require a few hand tools and small fasteners.

48228320

**\$220**



## PACKOUT™ Low-Profile Compact Organiser

Features:

- Perfect for secure storage of small items
- Items stay inside each bin when lid is closed
- Includes 4 small and 1 large bin plus dividers
- Clear lid for easy identification of contents
- Reinforced hinge & heavy duty latches
- IP65 Rated Weather Seal

48228436

**\$65**



## PACKOUT™ Deep Organiser

Our PACKOUT™ Deep Organiser provides a heavy duty storage and transport solution for those users with large fittings and accessories. The transparent lid of the Deep Organiser allows users to easily identify the right accessories for the job, while its no-travel seals prevent contents from moving around inside. With an IP65 rated seal, tools, accessories and fittings will be protected from weather and jobsite debris, while each Deep Organiser comes with quick-adjust dividers that allow the user to customise their unit exactly as needed. Part of the PACKOUT™ platform, the Deep Organiser attaches securely to any other PACKOUT™ product for ultimate transport and organisation on the jobsite.

48228432

**\$165**



## PACKOUT™ Tool Box

Great for storing your favourite power tool and the associated accessories. Includes an internal organizer trays for small parts and hand tools.

Features:

- 34kg weight capacity
- IP65 Rated seal
- Connects with all PACKOUT™ components

48228424

**\$175**



## PACKOUT™ Tool Box with Foam Insert

Supplied with customisable foam insert to protect your tools from damage during transportation. Impact resistant and stackable as part of the PACKOUT™ system.

48228450

**\$190**



## PACKOUT™ Rolling Tool Chest

Designed for bulkier tools and jobsite materials, our PACKOUT™ Rolling Tool Chest combines the benefits of a greater internal capacity and a Dual Stack Top to allow you to carry more around the jobsite. Constructed with impact-resistant polymers and water and debris protection, as well as an industrial-grade extension handle and 9" all terrain wheels, the Rolling Tool Chest can be rolled anywhere in any weather.

48228428

**\$590**



## PACKOUT™ Mounting Plate

The MILWAUKEE® PACKOUT™ Mounting Plate is constructed with impact resistant polymers, giving you up to a 45kg weight capacity when mounted to the floor and 22kg when mounted to walls.

Features:

- Wall & Floor Mounting
- 45kg Weight Capacity - Floor Mounted
- 22kg Weight Capacity - Wall Mounted
- Metal Reinforced Mounting Holes
- Metal Reinforced Tie-Down Points

48228485

**\$65**



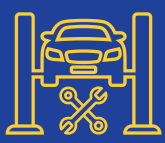

# MILWAUKEE® POWER TOOLS

## M18 FUEL™ Air Compressor

### Features:

- Targeted to carpenters/ remodelers, the compressor provides portability, power and quiet operation for pneumatic nailers and staplers
- Lightweight (14kg)
- Quiet (68dBA)

**M18FAC-0**  
(Tool Only)

**\$840**



**M18 FUEL**  
DRIVEN TO OUTPERFORM.

## M18™ Cordless Right Angle Impact Wrench

Offers users maximum access, and ultimate speed & control over their hard to reach fastening applications. Its 36mm head profile fits where pistol-grip impact tools cannot, and its extended paddle switch allows tradesmen to operate their tool from multiple grip points.

**M18BRAIW-0**  
(Tool Only)

**\$312**



**M18**

## M18™ LED Inspection Light

The high setting provides 300 Lumens and 140 Lux for maximum coverage and light output, while the Low setting provides 150 lumens and 70 Lux for interior work where a brighter light may not be necessary.

**M18IL-0**  
(Tool Only)

**\$132**



**M18**

## M18™ Jobsite Fan

### Features:

- Powerful Airflow System: Circulates Air Over 12m
- Adjustable Head: 120° Adjustable Head, and 9 Stopping Positions, provide Best Control of Airflow Direction
- AC Adaptor Included for Extended Run-Time
- Compatible with all M18™ REDLITHIUM™-ION Batteries

**M18AF-0**  
(Tool Only)

**\$180**



**M18**

## M18™ Pivoting Area Light

The most versatile flood light for any task. The M18™ Pivoting Area Light is designed to work in any workspace, jobsite, and on any surface. It has two powerful magnets allowing users to mount this light to almost any metal surface. It also has a 51mm (2") spring loaded clamp giving the user the ability to fix this light to piping, dimensional lumber, jobsite equipment, and cabinetry & doors.

**M18PAL-0**  
(Tool Only)

**\$252**



**M18**

## M18™ REDLITHIUM™-ION 5.0Ah Dual Bay Starter Pack

### Includes:

- 2x M18™ REDLITHIUM™-ION 5.0Ah Battery
- M18™ Dual Bay Simultaneous Rapid Charger

**M18SPD502B**

**\$636**



**M18**

## M18™ REDLITHIUM™-ION HIGH OUTPUT™ 8.0Ah Dual Bay Starter Pack

### Includes:

- 2pc M18™ REDLITHIUM™-ION HIGH OUTPUT™ 8.0Ah Battery
- M18™ Dual Bay Simultaneous Rapid Charger

**M18HOSPD802B**

**\$840**



**M18**

## M18™ REDLITHIUM™-ION 5.0Ah Resistant Battery

The M18™ REDLITHIUM™-ION 5.0Ah Resistant Battery is built with a resistant housing, providing increased protection against exposure to common oils, greases, and solvents found in transportation maintenance and manufacturing environments.

**M18CB5**  
(Battery Only)

**\$270**



**M18**

## M12™ & M18™ Super Charger

The charger accepts all M12™ & M18™ batteries, providing an upgrade for both M12™ & M18™ systems. The M18™ REDLITHIUM™-ION HIGH OUTPUT™ 12.0Ah battery fully charges in only 1 hour.

**M12-18SC**  
(Charger Only)

**\$336**



**M12 M18**

## M12™ REDLITHIUM™-ION HIGH OUTPUT™ 2.5Ah Starter Pack

Delivers 25% more power and runs 25% cooler than the M12 REDLITHIUM™-ION 2.0Ah Compact Battery. This increased performance of the lithium-ion battery gives you the same power and runtime of an M12™ REDLITHIUM™-ION battery in a lighter and more compact package.

**M12HOSP201B**

**\$180**



**M12**

## M12™ REDLITHIUM™-ION 4.0Ah Battery

Delivers maximum runtime, maximum power and more recharges than standard lithium-ion batteries. The M12™ REDLITHIUM™-ION 4.0Ah Battery features superior pack construction, electronics and performance to deliver more work per charge and more work over pack life than any battery on the market.

**M12B4**  
(Battery Only)

**\$168**



**M12**

## M12™ REDLITHIUM™-ION HIGH OUTPUT™ 5.0Ah Battery

The M12™ REDLITHIUM™-ION HIGH OUTPUT™ 5.0Ah Battery delivers 25% more power and runs 25% cooler than the M12™ REDLITHIUM™-ION 4.0Ah Battery. The increase in power elevates the performance of the entire M12™ system and drives the next breakthrough in M12 FUEL™.

**M12HB5**  
(Battery Only)

**\$179**



**M12**





## M12 FUEL™ 3pc Power Pack 3Q

- Includes:**
- M12 FUEL™ 3/8" Impact Ratchet (Tool Only)
  - M12 FUEL™ 3/8" Stubby Impact Wrench with Friction Ring (Tool Only)
  - M12™ Compact Inflator (Tool Only)
  - M12™ 4.0Ah REDLITHIUM™-ION Battery Pack
  - M12™ 3.0Ah REDLITHIUM™-ION Compact Battery
  - M12™ Lithium-Ion Battery Charger

M12FPP3Q-432B

**\$900**



**M12 FUEL**  
DRIVEN TO OUTPERFORM.

## M12 FUEL™ 1/2" Stubby Impact Wrench Socket Kit with Friction Ring

- Includes:**
- M12 FUEL™ 1/2" Stubby Impact Wrench with Friction Ring (Tool Only)
  - 2x M12™ REDLITHIUM™-ION 2.0Ah Compact Battery
  - M12™ Lithium-ion Battery Charger
  - SHOCKWAVE™ 1/2" Drive 12pc Metric Standard 6 Point Impact Socket Set

M12FIWF12202BS

**\$564**



**M12 FUEL**  
DRIVEN TO OUTPERFORM.

## M12 FUEL™ 1/4" Hex Impact Driver

The M12 FUEL™ 1/4" Hex Impact Driver has Fast Driving Speed, is More Compact, and provides Maximum Workspace Visibility. The POWERSTATE™ Brushless motor delivers the fast driving speeds in the subcompact class for maximum productivity. Being only 127 mm in length, allows for greater access in tight spaces and overall portability.

M12FID20  
(Tool Only)

**\$330**



**M12 FUEL**  
DRIVEN TO OUTPERFORM.

## M12™ Cordless 3/8" Impact Ratchet

The M12™ Cordless 3/8" Impact Ratchet is the ideal tool for auto mechanics, maintenance and repair professionals looking for maximum performance and productivity in a subcompact cordless tool.

M12IR-0  
(Tool Only)

**\$240**



**M12**

## M12 FUEL™ 1/2" Right Angle Impact Wrench

Provides maximum access with the ultimate control.

- Features:**
- Compact for greater access in tight spaces
  - Up to 300Nm of Nut-busting torque
  - Auto shut-off mode

M12FRAIWF12-0  
(Tool Only)

**\$335**



**M12 FUEL**  
DRIVEN TO OUTPERFORM.

## M12 FUEL™ Low Speed Tyre Buffer

- Features:**
- Power to Complete Commercial Flat Repair
  - 2-Modes for Consistent Flat Repair
  - Up to 30 Repairs per charge (on a M12b4)

M12FTB-0  
(Tool Only)

**\$270**



**M12 FUEL**  
DRIVEN TO OUTPERFORM.

## M12 FUEL™ 3/8" High Speed Ratchet

This is the fastest compact ratchet on the market that delivers 47Nm of torque at 450rpm.

- Features:**
- The fastest speed while installing and removing fasteners
  - Compact head design gives greater access to tight spaces
  - Can be used manually without engaging the tool's motor

M12FHIR38-0  
(Tool Only)

**\$330**



**M12 FUEL**  
DRIVEN TO OUTPERFORM.

## M12 FUEL™ Insider Extended Reach Pass-Through Ratchet w/ Insert Accessories

- 13pc Metric INSIDER™ Box Ratchet Sockets: 8, 9, 10, 11, 12, 13, 14, 15, 16, 17, 18, 19 & 21mm
- 3 INSIDER™ Box Ratchet Adapters: 1/4" Hex, 1/4" Anvil, 3/8" Anvil

M12FPTR0  
(Tool Only)

**\$509**



**M12 FUEL**  
DRIVEN TO OUTPERFORM.

## M12 FUEL™ 1/4" High Speed Extended Reach Ratchet

- Features:**
- Delivers 450rpm under load
  - Extended reach and small head size paired with compact yoke housing allows for easier access in tight spaces

M12FHIR14LR0  
(Tool Only)

**\$350**



**M12 FUEL**  
DRIVEN TO OUTPERFORM.

## M12 FUEL™ 3/8" Digital Torque Wrench with ONE-KEY™

The M12 FUEL™ 3/8" Digital Torque Wrench w/ ONE-KEY™ is the industry's first torque wrench with a motor, delivering increased productivity, precise torque accuracy, and user-demanded reporting functionality. The 3/8" Digital Torque Wrench delivers simplified installation, replacing the hand tool or two-tool installation process with the POWERSTATE™ Brushless Motor and torque wrench in the one tool.

M12ONEFTR38-OC  
(Tool Only)

**\$870**



**M12 FUEL**  
DRIVEN TO OUTPERFORM.

## M12 FUEL™ 3/8" Stubby Impact Wrench with Friction Ring

Our M12 FUEL™ 3/8" Stubby Impact Wrench with Friction Ring is the industry's most compact cordless impact wrench. At only 122mm in length, it allows you to work in tighter spaces delivering the power to complete many of the most demanding tasks and increasing your productivity. The compact impact delivers high torque with our POWERSTATE™ brushless motor.

- Features:**
- Compact for greater access in tight spaces
  - Up to 339Nm of Nut-busting torque
  - 4 Mode drive control

M12FIW38-0  
(Tool Only)

**\$372**



**M12 FUEL**  
DRIVEN TO OUTPERFORM.

## M12™ Compact Inflator

Easy inflation with the portability to take anywhere. The inflator will stop automatically once the entered tyre pressure is reached.

- Features:**
- Max Pressure: 120psi
  - True fill auto shut-off
  - Easy to read LCD screen

M12BI-0  
(Tool Only)

**\$209**



**M12**

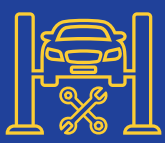

# MILWAUKEE® POWER TOOLS

## M12 FUEL™ Bandfile 10mm

The M12 FUEL™ Bandfile 10mm is a cordless bandfile that delivers pneumatic performance, size, and features for professional automotive, industrial, and metalworking users. The MILWAUKEE® Bandfile delivers fast spot weld removal by leveraging the POWERSTATE™ Brushless Motor Technology.

### Features:

- 2-Speed variation
- Variable speed trigger allows for feathering of trigger
- 360° tool-free arm rotation allows users to pivot the sand belt

### M12FBFL100

(Tool Only)

# \$395



**M12 FUEL**  
DRIVEN TO OUTPERFORM.

## M12 FUEL™ Straight Die Grinder

The M12 FUEL™ Straight Die Grinder is the first cordless straight die grinder that delivers the performance and size professional service mechanics demand. The die grinder delivers maximum power for heavy duty applications and features POWERSTATE™ Brushless Motor technology.

### M12FDGS-0

(Tool Only)

# \$343



**M12 FUEL**  
DRIVEN TO OUTPERFORM.

## M12™ Spot Polisher & Detail Sander

A 2-in-1 tool - sanding and polishing thanks to the dual speed mode controls and variable speed trigger.

### Includes:

- 5 piece accessory pack
- Polishing: 0-2, 800rpm
- Sanding: 0-8, 300rpm

### M12BPS-0

(Tool Only)

# \$240



**M12**

## M12™ LED Stick Light Stainless Steel Hook

### Features:

- Run-time, power and longer battery life
- Adjustable metal hook
- Compact size provides ability to fit into tight areas
- High output 3-LED design provides bright, even coverage

### M12SL-0

(Tool Only)

# \$120



**M12**

## M12™ Mounting Fan

The M12™ Mounting Fan delivers up to 23 km/h air speed anywhere on the jobsite, providing a maximum air volume of 680m<sup>3</sup>/h. The 152mm blade propels air at a fast rate, allowing for quick efficient cooling, drying and ventilation.

### Features:

- Up to 16 hours runtime when used with M12™ 6.0AH REDLITHIUM™-ION Battery
- Full 360° head rotation for use on all angles
- Compact 152.4 mm (6") blade diameter allows for use in tight spaces

### M12AF-0

(Tool Only)

# \$180



**M12**

## M12™ LED Undercarriage Light

The M12™ LED Undercarriage Light is the first of its kind, revolutionising the way automotive mechanics execute undercarriage work. This innovative light delivers unmatched maneuverability and hands-free lighting.

### Features:

- Strong magnetic base and twin swivel points get light exactly where it's needed 305mm magnetic storage tray to hold nuts and bolts
- Lumens: 1,200 (High), 800 (Medium), 600 (Low)
- Run time hours: 5 (High), 8 (Medium), 15 (Low)

### M12UCLO

(Tool Only)

# \$324



**M12**

## REDLITHIUM™ USB Rechargeable Slide Focus Flashlight Kit

### Features:

- Slide focusing for quick and easy customisation of beam size and intensity
- Four modes, up to 2,000 lumens of TRUEVIEW™ High Definition Output
- Up to 24 hours of runtime

### L4FL2000301

# \$210



**M12**

## REDLITHIUM™ USB Rechargeable Stick Light 3.0Ah Kit

The Stick Light features dual lighting panels and a flashlight which provides both area and spotlight capabilities. The REDLITHIUM™ USB Rechargeable Stick Light has 550 lumens of TRUEVIEW™ High Definition output, giving you the ability to search, trace or inspect from further away.

### L4SL550301

# \$156



**M12**

## REDLITHIUM™ USB Rechargeable Neck Light Kit

### Features:

- Two modes, up to 400 lumens of TRUEVIEW™ High Definition Output
- Up to 8 hours runtime when used with REDLITHIUM™ USB 3.0Ah Battery Pack
- 130° of vertical rotation for complete light head adjustability

### L4NL400301

# \$210



**M12**

## 12:1 Infrared Temp-Gun

The MILWAUKEE® Infrared Temp-Gun delivers the clearest screen and faster scanning. With stunning readability indoor & outdoor, this infrared temp-gun provides easier readings for professional, residential, commercial and industrial users in any environment.

### 2268-40

# \$204



**M12**

## M12™/ M18™ Wireless Jobsite Speaker

The MILWAUKEE® M12™/M18™ Wireless Jobsite Speaker delivers the loudest and clearest sound on or off the job site. The premium six-speaker design provides unmatched clarity of sound with booming bass, clear mids, and sharp highs.

### M12-18JSSP-0

(Tool Only)

# \$348



**M12 M18**

## M12™ M-Spector FLEX™ Inspection Camera Cable Kit

The M12™ M-SPECTOR FLEX™ Inspection Camera Cable Kit is the only contractor inspection camera that gives users the ability to see more, easier, faster. The kit's 274cm cable gives users extended reach in pipes and air ducts without the hassle of buying and connecting additional bulky, inflexible extensions.

### M12ICAV3-90C

(Tool Only)

# \$900



**M12**

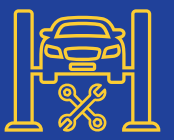

## M18 FUEL™ 4pc Power Pack 4B3

- Includes:**
- M18 FUEL™ 13mm Hammer Drill/Driver (Tool Only)
  - M18 FUEL™ 1/2" Compact Impact Wrench with Friction Ring (Tool Only)
  - M18 FUEL™ 125mm 5" Angle Grinder with Deadman Paddle Switch (Tool Only)
  - M18 FUEL™ ONE-KEY™ 3/4" High Torque Impact Wrench with Friction Ring (Tool Only)
  - 2x M18™ 5.0Ah REDLITHIUM™-ION Battery
  - M12™ & M18™ Rapid Charger
- M18FPP4B3502B**

**\$1,680**



**M18 FUEL**  
DRIVEN TO OUTPERFORM.

## M18 FUEL™ 3pc Power Pack 3N2

- Includes:**
- M18 FUEL™ 1/2" Mid-Torque Impact Wrench with Friction Ring (Tool Only)
  - M12 FUEL™ 3/8" Stubby Impact Wrench with Friction Ring (Tool Only)
  - M12 FUEL™ 3/8" Impact Ratchet (Tool Only)
  - PACKOUT™ Tool Box
  - M18™ REDLITHIUM™-ION 5.0Ah Battery
  - 2x M12™ REDLITHIUM™-ION 2.0Ah Compact Battery
  - M12™ & M18™ Rapid Charger
- M18FPP3N2-523P**

**\$1,440**



**M18 FUEL**  
DRIVEN TO OUTPERFORM.

## M18™ Cordless 2-Speed Grease Gun Kit

- Includes:**
- M18™ Cordless 2-Speed Grease Gun
  - M18™ 2.0Ah REDLITHIUM™-ION Compact Battery
  - M12™ & M18™ Rapid Charger
- M18GG-201B**

**\$865**



**M18**

## M18 FUEL™ 1" D-Handle Extended Anvil High Torque Impact Wrench with ONE-KEY™

The world's most powerful cordless impact wrench with 2,711Nm of nut-busting torque. Ideal for heavy industry - transport, Rail, Forestry, etc.

- Features:**
- 4-Mode Drive Control
  - Tri-LEDs

**M18ONEFHIWF1D-0**  
(Tool Only)

**\$2,160**



**M18 FUEL**  
DRIVEN TO OUTPERFORM.

## M18 FUEL™ ONE-KEY™ 1" High Torque Impact Wrench with Friction Ring

The M18 FUEL™ 1" High Torque Impact Wrench w/ ONE-KEY™ is the world's first cordless 1" High Torque Impact Wrench. The POWERSTATE™ Brushless Motor delivers up to 2,440Nm of nut-busting torque and 2,033Nm of fastening torque, making this the most powerful cordless impact wrench and enabling you to complete the most demanding applications.

- Features:**
- Eliminates compressors and generators
  - Up to 3.1kg lighter weight allowing for less user fatigue

**M18ONEFHIWF1-0**  
(Tool Only)

**\$1,020**



**M18 FUEL**  
DRIVEN TO OUTPERFORM.

## M18 FUEL™ ONE-KEY™ 3/4" High Torque Impact Wrench with Friction Ring

With 2,034Nm of nut-busting torque and 1,627Nm of fastening torque, this 3/4" Dr. Impact Wrench gives the user maximum power and repeatability.

- Features:**
- ONE-KEY™ for tool tracking and management
  - 4 mode customisable drive control
  - LED light to illuminate the work area

**M18ONEFHIWF34-0**  
(Tool Only)

**\$756**



**M18 FUEL**  
DRIVEN TO OUTPERFORM.

## M18 FUEL™ ONE-KEY™ 1/2" Impact Wrench with Friction Ring

The M18 FUEL™ 1/2" Compact Impact Wrench is the most powerful tool in its class, delivering up to 300Nm of torque in a compact design. The POWERSTATE™ Brushless Motor not only provides unmatched power, but also greater efficiency, delivering up to 25% more run-time than the leading competitors.

**M18ONEIWF12-0**  
(Tool Only)

**\$480**



**M18 FUEL**  
DRIVEN TO OUTPERFORM.

## M18 FUEL™ 1/2" Compact Impact Wrench with Friction Ring

The M18 FUEL™ 1/2" Compact Impact Wrench with Friction Ring delivers maximum access in tight spaces, up to 339 Nm of nut-busting torque, and maximum workspace visibility. This battery-powered impact wrench measures only 124.5 mm in length, with a POWERSTATE™ Brushless Motor to provide the power to remove stubborn fasteners, even in confined spaces.

**M18FIW2F12-0**  
(Tool Only)

**\$408**



**M18 FUEL**  
DRIVEN TO OUTPERFORM.

## M18 FUEL™ 1/2" Mid-Torque Impact Wrench with Friction Ring

Compact, lightweight, yet powerful delivering up to 881Nm of nut-busting torque, and maximum power to weight ratio. Weighing only 1.58kg makes it extremely versatile, capable of performing a wide variety of applications. Gains access into tight areas without compromising power.

**M18FMTIW2F12-0**  
(Tool Only)

**\$540**



**M18 FUEL**  
DRIVEN TO OUTPERFORM.

## M18 FUEL™ 1/2" High Torque Impact Wrench with Friction Ring

The industry's most compact cordless High Torque Impact wrench at 213mm in length, this tool allows for more access in tight spaces. 4-Mode DRIVE CONTROL with Bolt Removal mode gives users the most control over their fasteners.

**M18FHIWF12-0**  
(Tool Only)

**\$660**



**M18 FUEL**  
DRIVEN TO OUTPERFORM.

## M18™ Inflator

- Features:**
- Fast cordless inflating - Top off 33" truck tyres in under 1 min & up to 30 tyres on a M18 5.0Ah battery
  - Rated for 150psi Max
  - 915mm inflation hose
  - Auto pressure check indicator

**M18BI0**  
(Tool Only)

**\$360**



**M18**

## M18 FUEL™ 150mm 6" Random Orbital Polisher

The M18™ FUEL™ Random Orbital Polisher delivers corded performance while providing you with the freedom to work anywhere.

- Features:**
- POWERSTATE™ Brushless Motor delivers 2,400-4,500rpm with an 8-position speed dial and maintains speed under load
  - Frees you from cord management, maintenance, and the fear of surface damage with best-in-class clearance of more than 50mm

**M18FR0P1500**  
(Tool Only)

**\$480**



**M18 FUEL**  
DRIVEN TO OUTPERFORM.



# THE BRANDS, RANGE & SERVICE TO KEEP YOUR WORKSHOP **MOVING.**



Air Conditioning



Cooling



Braking



Automotive Electrical



Servicing

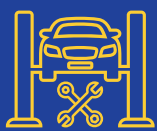

Tools and Equipment



Clutch and Driveline



Steering and Suspension

## AUCKLAND & NORTHLAND

North Shore	09 444 1313	Pukekohe	09 238 5400
Henderson	09 838 8725	Waipapa	09 283 5947
New Lynn	09 827 3047	Whangarei	09 438 7319
Otaguhu	09 276 3852	Penrose	
East Tamaki	09 274 6510	Auto Electrical	09 573 0680
Manukau	09 263 6363	General Mechanical	09 622 3424
		Trans & 4x4	0800 333 125

## WAIKATO TO WELLINGTON

Hamilton	07 847 0456	Palmerston North	06 355 3223
Tauranga	07 578 8175	Napier	06 834 0640
New Plymouth	06 759 4975	Lower Hutt	04 384 7074

## SOUTH ISLAND

Sydenham	03 365 5724	Dunedin	03 456 2318
Hornby	03 348 6526	Invercargill	03 218 9093

## SULCO

Sulco.co.nz	0800 800 488
-------------	--------------

# BRANDS, RANGE AND SERVICE TO KEEP YOUR WORKSHOP **MOVING.**

From a proud heritage of automotive electrical and air conditioning Know How, we have diversified our range, knowledge, and solutions as we look to the future.

We see a growing demand for mechanical products in the automotive industry. From transmissions to braking systems to servicing parts, mechanical components are critical to a vehicle's performance and safety.

We have expanded into these new ranges to offer a complete solution and provide the widest product range for all your automotive parts needs.

Visit [napa.co.nz](http://napa.co.nz) for your nearest branch.



• [www.napa.co.nz](http://www.napa.co.nz) • 0800 800 073

Offer only valid for NAPA Auto Parts and Sulco account holders. Price may be subject to freight where applicable. All products were available in stock at time of printing. Slight delays may occur if your branch is out of stock. Pictures are for illustration purposes only. GPC Asia Pacific reserves the right to correct pricing where printing errors have occurred. ALL PRICES EXCLUDE GST. PRICES VALID 01/01/24 UNTIL 31/03/24.